

Ordering Information pg. 31

TYPE J
8P8C

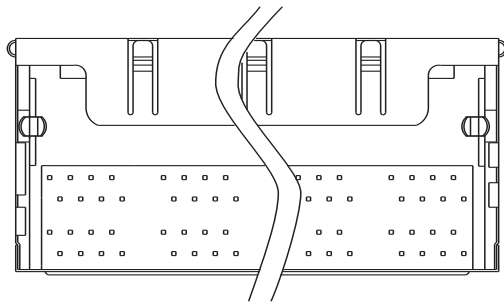

MTJG-8-88JX1-FSG-PG

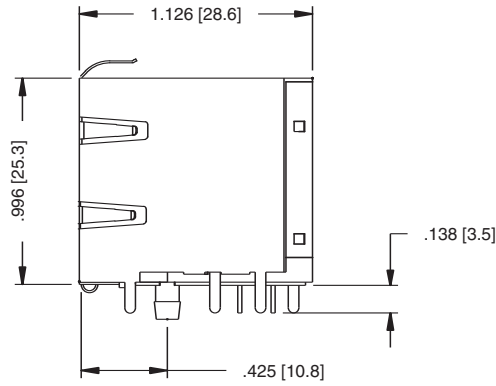
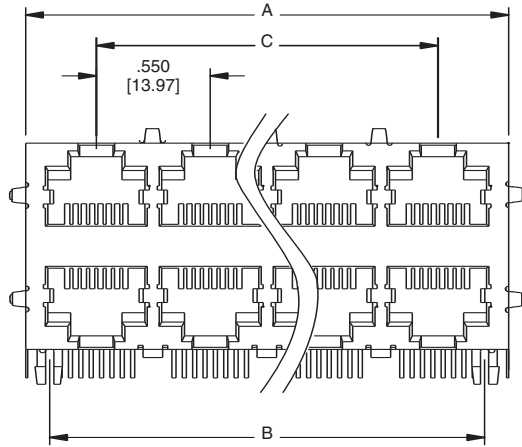
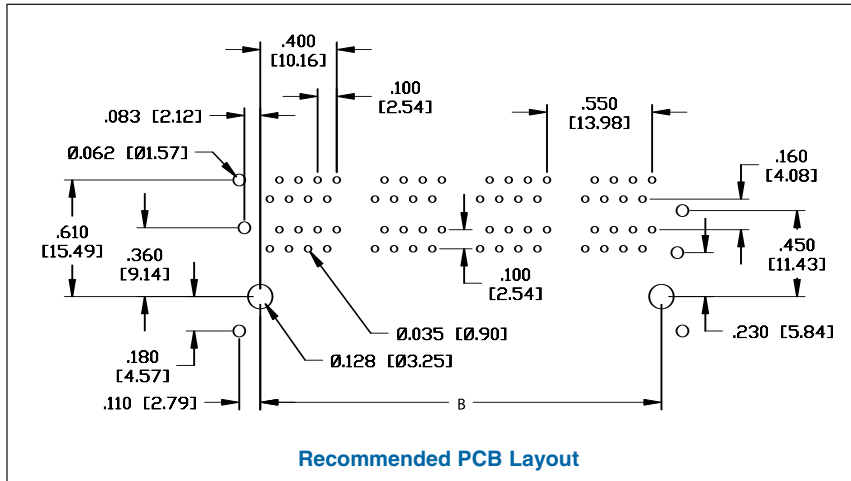

Recommended PCB Layout

PART NUMBER	PORTS	DIMENSIONS		
		A	B	C
MTJG-2-88JX1-FSG-PG	2 X 1	.679 [17.25]	.450 [11.43]	—
MTJG-4-88JX1-FSG-PG	2 X 2	1.230 [31.25]	1.00 [25.40]	.550 [13.97]
MTJG-6-88JX1-FSG-PG	2 X 3	1.780 [45.21]	1.549 [39.34]	1.100 [27.94]

PART NUMBER	PORTS	DIMENSIONS		
		A	B	C
MTJG-8-88JX1-FSG-PG	2 X 4	2.33 [59.18]	2.100 [53.34]	1.650 [41.91]
MTJG-12-88JX1-FSG-PG	2 X 6	3.43 [87.10]	3.200 [81.28]	2.750 [69.85]
MTJG-16-88JX1-FSG-PG	2 X 8	4.537 [115.25]	4.30 [109.22]	3.850 [97.79]