

Ordering Information pg. 9

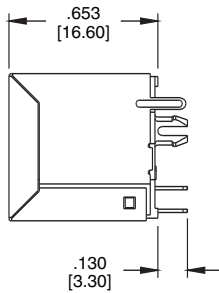
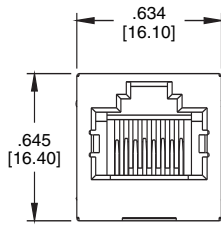

MTJ-88AX1-FSE

TYPE A
CATEGORY 5, TOP ENTRY
8P8C

Recommended PCB Layout

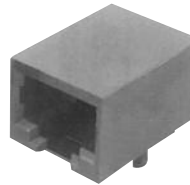
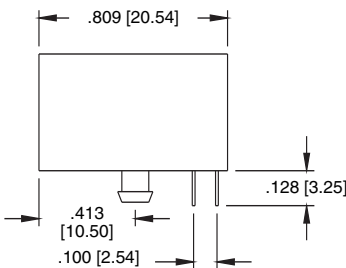
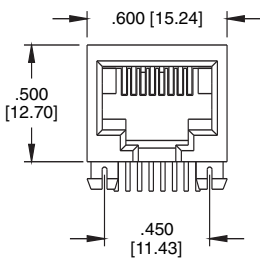
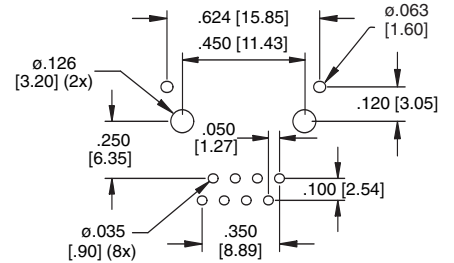

MTJ-88TX1

TYPE T
CATEGORY 5, SIDE ENTRY
8P8C

Recommended PCB Layout

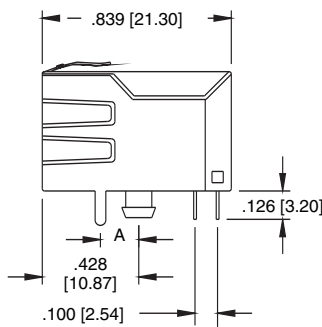
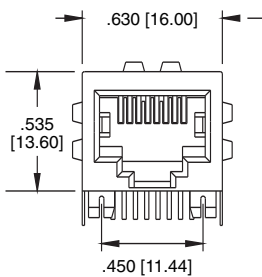
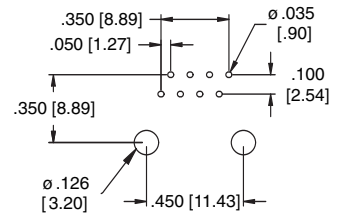

FSA, FSB & FSE

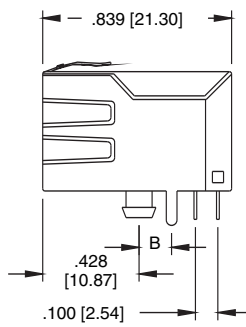

FSD = .120 [3.05]



MTJ-88TX1-FSE-PG
Available with or without panel ground tabs

TYPE T
CATEGORY 5, SHIELDED
8P8C

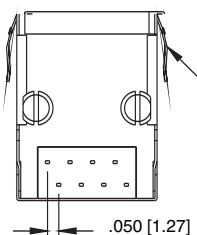

OPTIONAL
PANEL GROUND TABS
SHIELD PIN LOCATION OPTIONS
FSA OPTION: A = .170 [4.32]
FSB OPTION: A = .144 [3.66]
FSE OPTION: A = .120 [3.05]

PCB Layout (FSD)

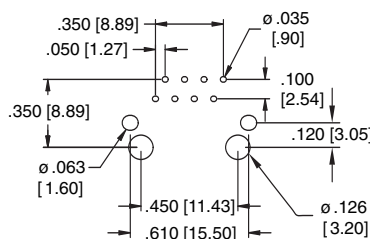

PCB Layout (FSA, FSB & FSE)

