

TYPE A, CATEGORY 5, TOP ENTRY

8P8C

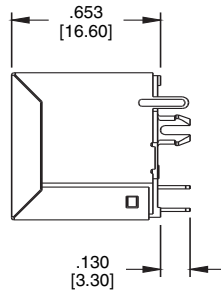
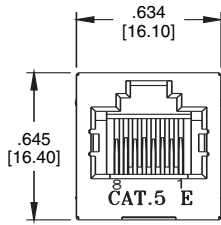

MTJ-88AX1-FSE

Recommended PCB Layout

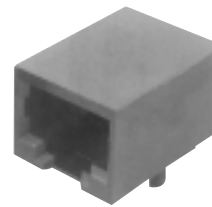
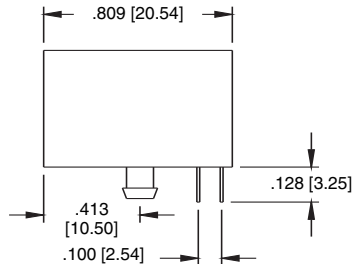
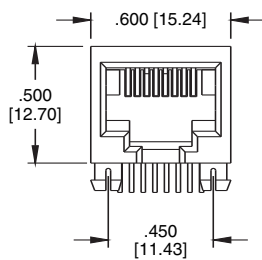
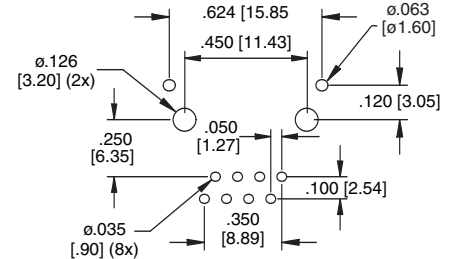

MTJ-88TX1

TYPE T, CATEGORY 5, SIDE ENTRY

8P8C

Recommended PCB Layout

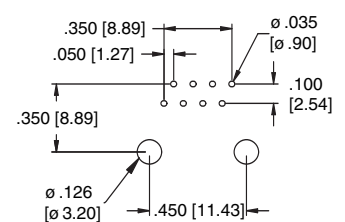

TYPE T, CATEGORY 5 SHIELDED SIDE ENTRY

8P8C

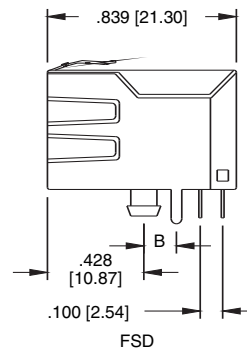
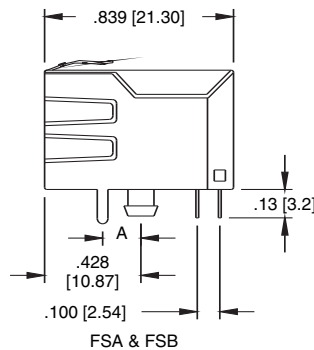
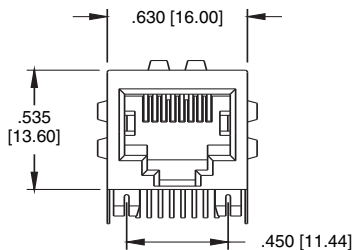

MTJ-88TX1-FSE-PG6

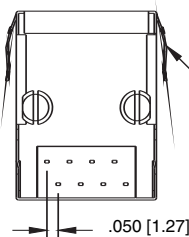

OPTIONAL
PANEL GROUNDS

SHIELD PIN LOCATION
FSA OPTION: A = .170 [4.32]
FSB OPTION: A = .144 [3.66]
FSE OPTION: A = .120 [3.05]

PCB Layout (FSD)

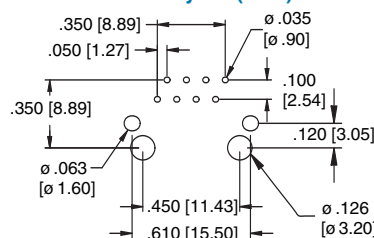

PCB Layout (FSA, FSB & FSE)

