

USB-A-S-RA

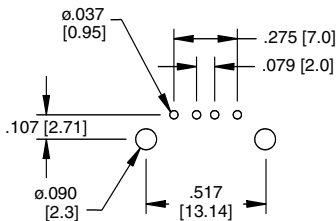

Recommended PCB Layout

USB-A-S-RA-SMT

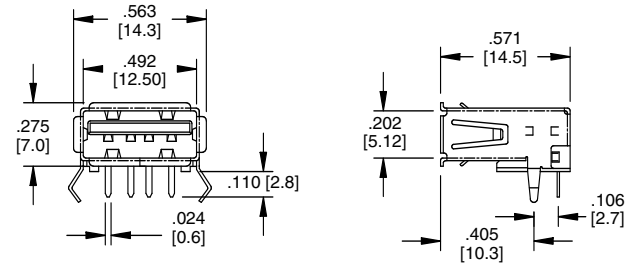
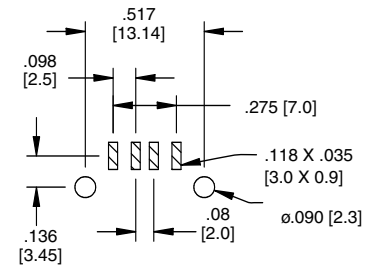
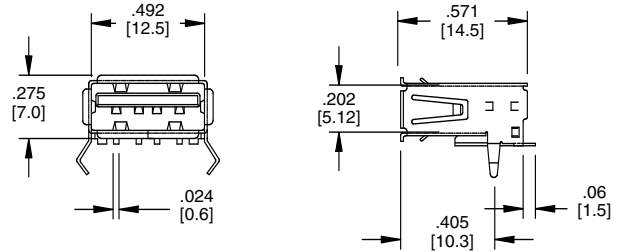

Recommended PCB Layout

USB-A-S-VT

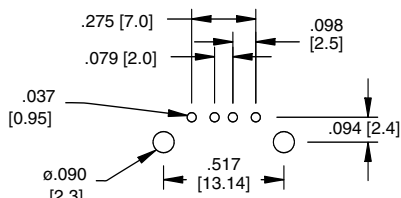
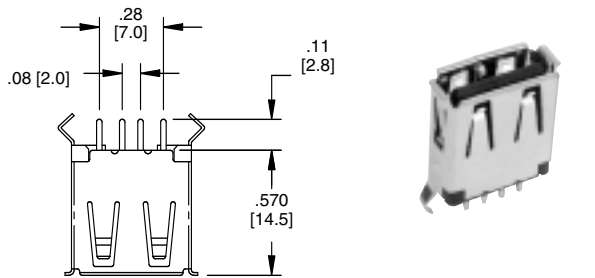

Recommended PCB Layout (Bottom View)

USB-A-D-RA

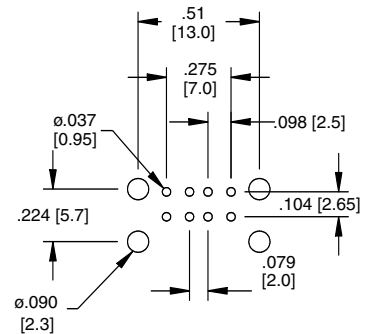
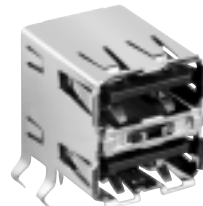

Recommended PCB Layout (Bottom View)

