

APPROVED: _____
 DATE: _____ TITLE: _____

Rev	AWO #	Description	Date	Appr
-		RELEASED	2/5/09	
A		REVISED DIM.	1/10/11	

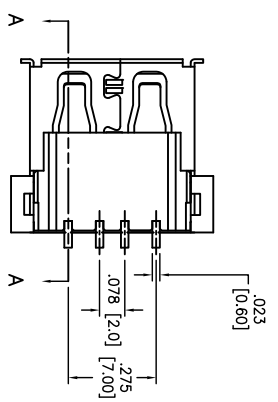
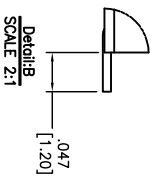
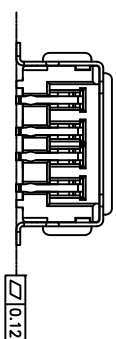
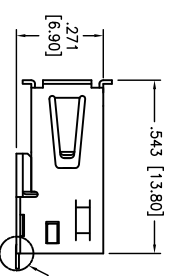
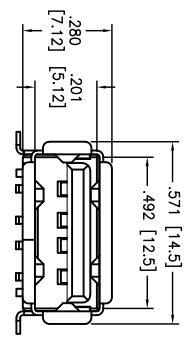
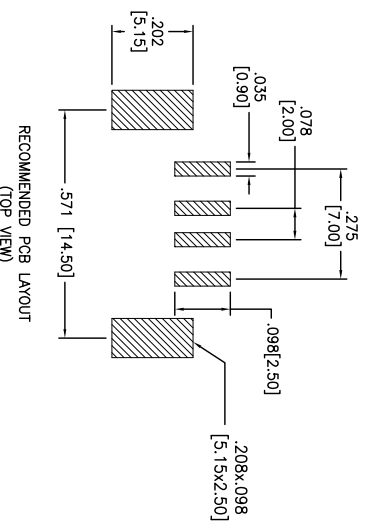
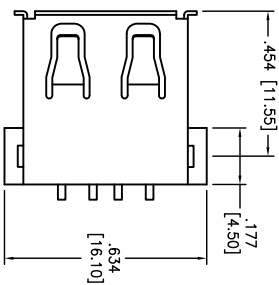

SPECIFICATIONS:

- Material: Insulator: Hi-Temp Nylon PA6T, rated UL 94V-0
- Insulator color: White
- Contacts: Brass
- Shell: Copper Alloy, nickel/Tin plated
- Contact Plating: Gold flash over Nickel on mating area, Tin over Copper underplate on tails.
- Electrical: Operating voltage: 30 VAC max. Current rating: 1.5 Amps max. Contact resistance: 30 mohms max. Insulation resistance: 1000 Mohms min. @ 500 VDC Dielectric withstanding voltage: 500 VAC for 1 minute
- Mechanical: Insertion force: 35 Newtons max. Withdrawal force: 10 Newtons min. Temperature Rating: Operating temperature: -20°C~+60°C

Environmental: Lead free, RoHS compliant. Recommended soldering temp: 260°C for 5 sec.



ADAM TECH

909 Rahway Avenue, Union, NJ 07083
 Phone: 908-687-5000 Fax: 908-687-5710

USB TYPE A, RIGHT ANGLE, TRUE SURFACE MOUNT, NO PEG, WHT INS.

UNLESS OTHERWISE SPECIFIED ALL DIMENSIONS ARE INCHES [MM]	
TOLERANCES: EXCEPT AS NOTED	
INCHES	HOLES
.X ± .10	ØXX ± .015
.XX ± .020	ØXXX ± .015
.XXX ± .015	ØXXXX ± .010
APPROVALS	DATE
DRAWN SS	2/5/09
CHECKED	
APPROVED	

TITLE	PART NO.	REV.
USB TYPE A, RIGHT ANGLE, TRUE SURFACE MOUNT, NO PEG, WHT INS.	USB-A-S-RA-TSMT-NP-WT	A
REF:	SCALE: NTS	SHEET 1 OF 1