

Rev	AWO #	Description	Date	Appr
-		RELEASED	10/26/09	

APPROVED: _____
 DATE: _____ TITLE: _____

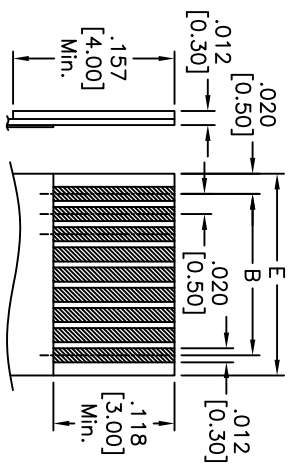
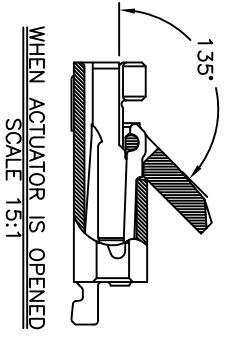
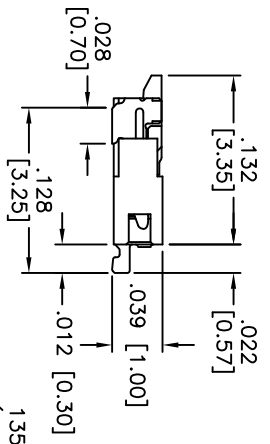
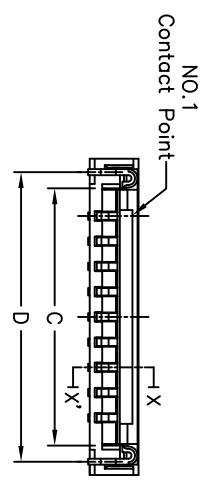
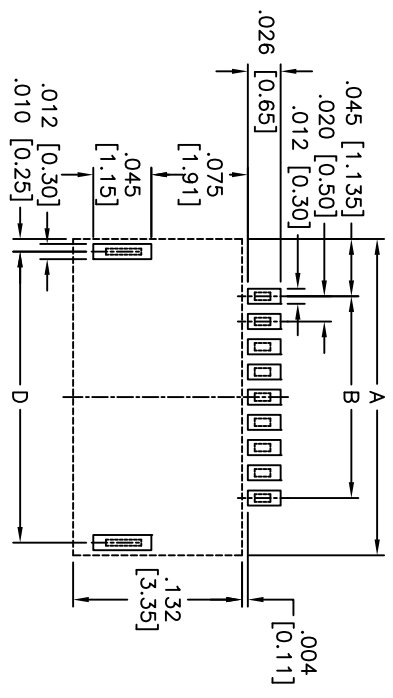
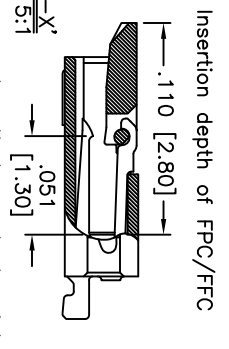
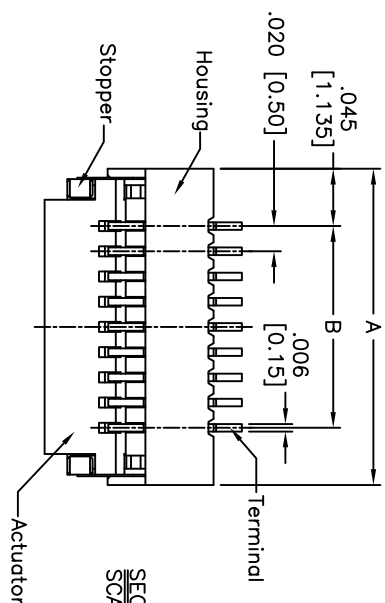

POSITIONS: 4 thru 50
 A = B + .089 [2.27]
 B = .020 [0.50] x No. of Spaces
 C = B + .043 [1.10]
 D = B + .070 [1.77]
 E = B + .039 [1.00]

SPECIFICATIONS:
 Material: LCP, rated UL 94V-0
 Housing: LCP, UL 94V-0
 Actuator: LCP, UL 94V-0
 Terminal: Phosphor Bronze
 Stopper: Phosphor Bronze, Tin over Nickel plated.
 Plating: Tin over Copper underplate overall
 Electrical: Tin over Copper underplate overall
 Operating voltage: 50 VAC max
 Current rating: 0.4 Amps max
 Temperature Rating: Operating temperature: -55°C to +85°C
 Environmental: Lead free, RoHS compliant.
 Recommended soldering temp: 260°C for 5 sec.



UNLESS OTHERWISE SPECIFIED ALL DIMENSIONS ARE INCHES [MM]	
TOLERANCES: EXCEPT AS NOTED	
INCHES	HOLDS
.X ± .10	ØX ± .10
.XX ± .020	ØXX ± .015
.XXX ± .015	ØXXX ± .010
APPROVALS	DATE
DRAWN	10/26/09
CHECKED	
APPROVED	

ADAM TECH
 909 Rahway Avenue, Union, NJ 07083
 Phone: 908-687-5000 Fax: 908-687-5710

TITLE: ZIF FLEX CIRCUIT CONNECTOR	
0.50 MM PITCH, SIDE ENTRY, SMT	
SIZE: X	PART NO.: PCA-6F-XX-HL-3
REF: S00079T	SCALE: NTS
SHEET 1 OF 1	REV: -