

Rev	AWO #	Description	Date	Appr
-		RELEASED	10/26/09	

APPROVED: _____
 DATE: _____ TITLE: _____

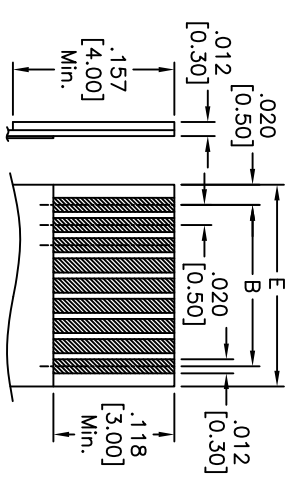

Positions: 4 thru 50
 A = B + .089 [2.27]
 B = .020 [0.50] x No. of Spaces
 C = B + .043 [1.10]
 D = B + .070 [1.77]
 E = B + .039 [1.00]

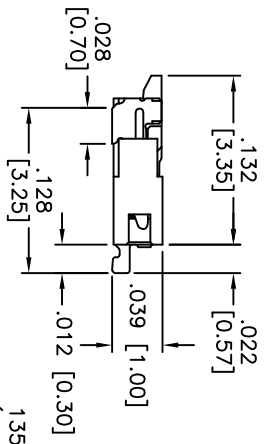
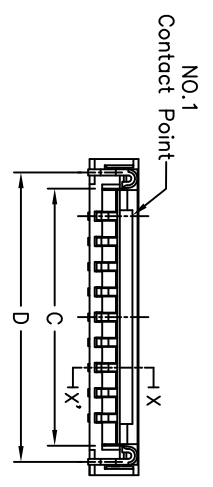
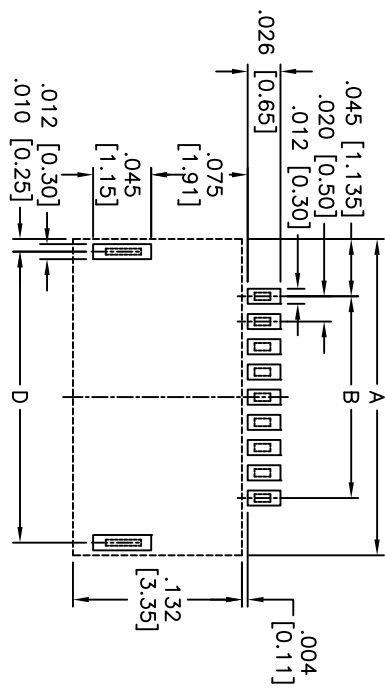
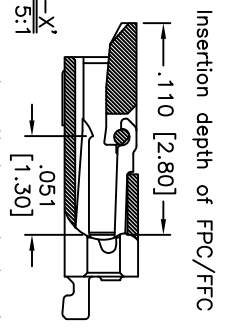
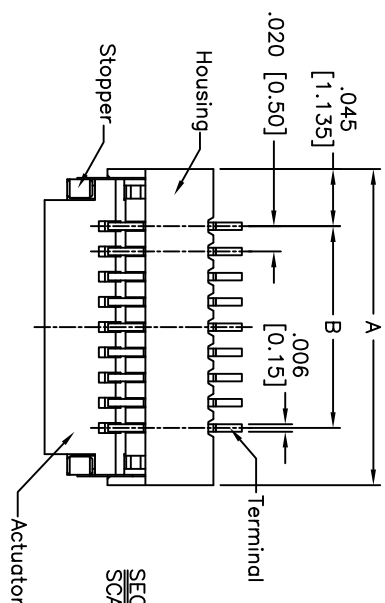
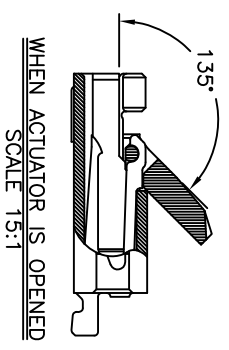

PACKAGED ON TAPE & REEL

Applicable FPC

SPECIFICATIONS:

- Material: LCP, rated UL 94V-0
- Housing: LCP, UL 94V-0
- Actuator: LCP, UL 94V-0
- Terminal: Phosphor Bronze
- Stopper: Phosphor Bronze, Tin over Nickel plated.
- Plating: Tin over Copper underplate overall
- Electrical: Tin over Copper underplate overall
- Operating voltage: 50 VAC max
- Current rating: 0.4 Amps max
- Temperature Rating: Operating temperature: -55°C to +85°C
- Environment: Lead free, RoHS compliant.
- Recommended soldering temp: 260°C for 5 sec.



UNLESS OTHERWISE SPECIFIED ALL DIMENSIONS ARE INCHES [MM]	
TOLERANCES: EXCEPT AS NOTED	
INCHES	HOLDS
.X ± .10	ØXX ± .10
.XX ± .020	ØXXX ± .015
.XXX ± .015	ØXXXX ± .010
APPROVALS	DATE
DRAWN	DY
CHECKED	
APPROVED	

ADAM TECH
 909 Rahway Avenue, Union, NJ 07083
 Phone: 908-687-5000 Fax: 908-687-5710

TITLE		ZIF FLEX CIRCUIT CONNECTOR	
0.50 MM PITCH, SIDE ENTRY, SMT		SIZE	PCA-6F-XX-HL-3-T/R
REV.		PART NO.	
		REF: S00079T	SCALE: NTS
			SHEET 1 OF 1