

Rev	AWO #	Description	Date	Appr
-		RELEASED	10/26/09	

APPROVED: \_\_\_\_\_  
 DATE: \_\_\_\_\_ TITLE: \_\_\_\_\_

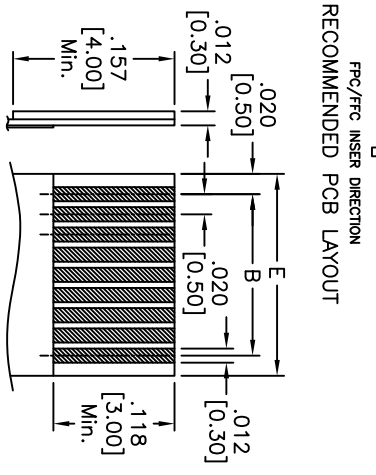
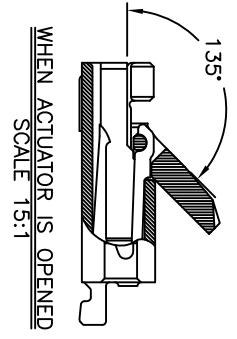
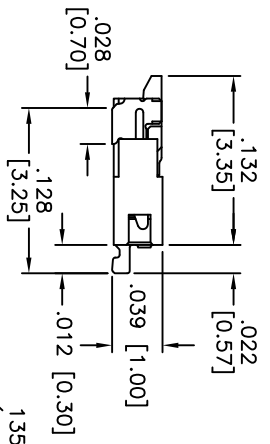
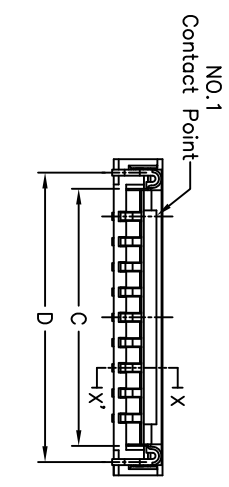
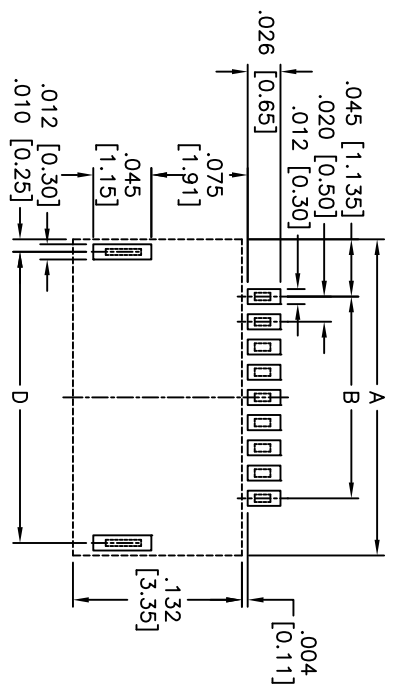
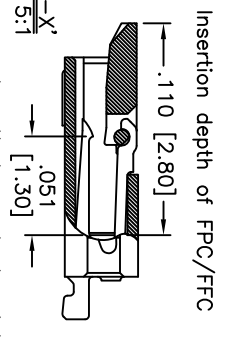
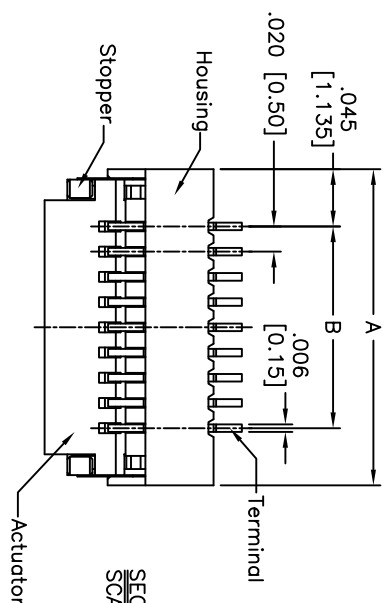

Positions: 4 thru 50  
 A = B + .089 [2.27]  
 B = .020 [0.50] x No. of Spaces  
 C = B + .043 [1.10]  
 D = B + .070 [1.77]  
 E = B + .039 [1.00]

**SPECIFICATIONS:**

**Material:** LCP, rated UL 94V-0  
**Housing:** LCP, UL 94V-0  
**Actuator:** LCP, UL 94V-0  
**Terminal:** Phosphor Bronze  
**Stopper:** Phosphor Bronze, Tin over Nickel plated.  
**Plating:** Gold flash over Nickel underplate overall  
**Electrical:** Operating voltage: 50 VAC max  
 Current rating: 0.4 Amps max  
**Temperature Rating:** Operating temperature: -55°C to +85°C  
**Environmental:** Lead free, RoHS compliant.  
**Recommended soldering temp:** 260°C for 5 sec.



UNLESS OTHERWISE SPECIFIED ALL DIMENSIONS ARE INCHES [MM]	
TOLERANCES: EXCEPT AS NOTED	
INCHES	HOLDS
.X ± .10	± .10
.XX ± .020	± .015
.XXX ± .015	± .010
APPROVALS	DATE
DRAWN	10/26/09
CHECKED	
APPROVED	

**ADAM TECH**  
 909 Railway Avenue, Union, NJ 07083  
 Phone: 908-687-5000 Fax: 908-687-5710

TITLE	ZIF FLEX CIRCUIT CONNECTOR
SIZE	0.50 MM PITCH, SIDE ENTRY, SMT
PART NO.	PCA-6F-XX-HL-3-G
REV.	
REF: S00079T	SCALE: NTS
SHEET 1 OF 1	