

Rev	AWO #	Description	Date	Appr
-		RELEASED	10/26/09	

APPROVED: \_\_\_\_\_  
 DATE: \_\_\_\_\_ TITLE: \_\_\_\_\_

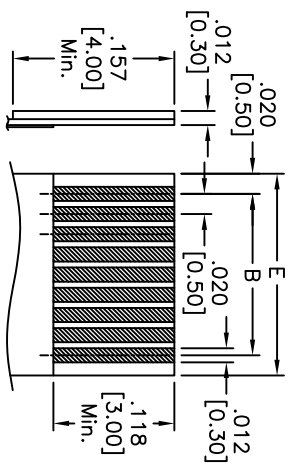
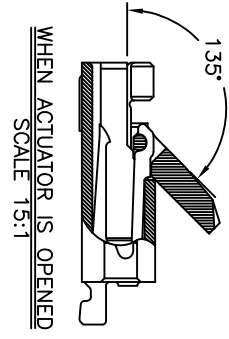
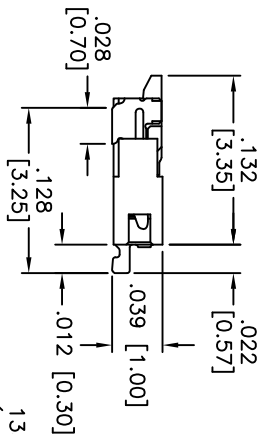
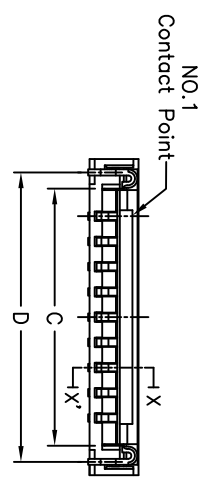
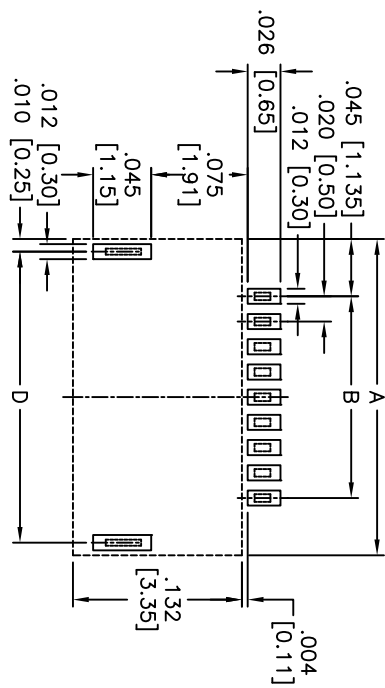
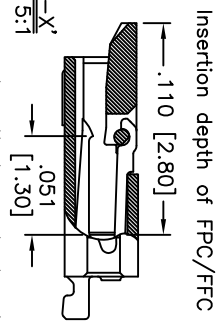
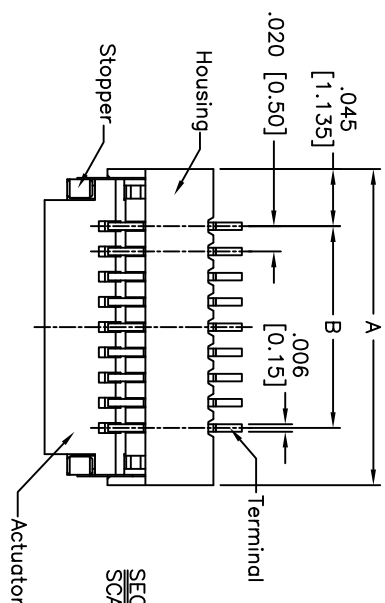

Positions: 4 thru 50  
 A = B + .089 [2.27]  
 B = .020 [0.50] x No. of Spaces  
 C = B + .043 [1.10]  
 D = B + .070 [1.77]  
 E = B + .039 [1.00]

PACKAGED ON TAPE & REEL

Applicable FPC

**SPECIFICATIONS:**

- Material: LCP, rated UL 94V-0
- Housing: LCP, UL 94V-0
- Actuator: LCP, UL 94V-0
- Terminal: Phosphor Bronze
- Stopper: Phosphor Bronze, Tin over Nickel plated.
- Plating: Gold flash over Nickel underplate overall
- Electrical: Operating voltage: 50 VAC max
- Current rating: 0.4 Amps max
- Temperature Rating: Operating temperature: -55°C to +85°C
- Environment: Lead free, RoHS compliant.
- Recommended soldering temp: 260°C for 5 sec.

**ADAM TECH**

909 Rahway Avenue, Union, NJ 07083  
 Phone: 908-687-5000 Fax: 908-687-5710

**ZIF FLEX CIRCUIT CONNECTOR**  
 0.50 MM PITCH, SIDE ENTRY, SMT

UNLESS OTHERWISE SPECIFIED ALL DIMENSIONS ARE INCHES [MM]	
TOLERANCES: EXCEPT AS NOTED	HOLDS
.X ± .10	± .10
.XX ± .020	± .015
.XXX ± .015	± .010
APPROVALS	DATE
DRAWN	DY
CHECKED	
APPROVED	

SIZE	PART NO.	REV.
X	PCA-6F-XX-HL-3-G-T/R	
REF: S00079T	SCALE: NTS	SHEET 1 OF 1

