

Rev	AWO #	Description	Date	Appr
-		RELEASED	5/5/05	

APPROVED: _____
 DATE: _____ TITLE: _____

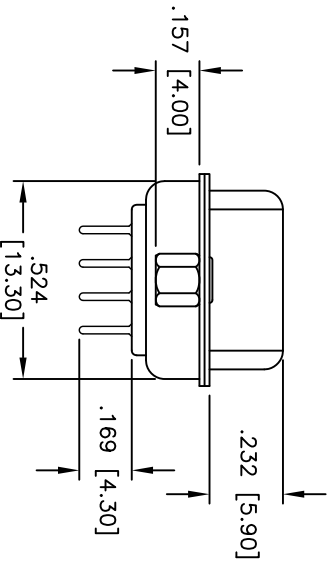
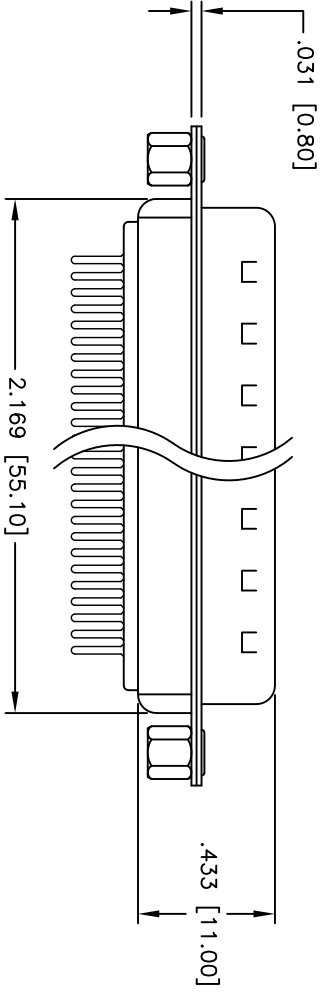
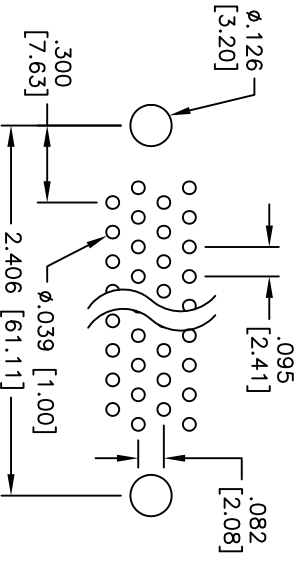
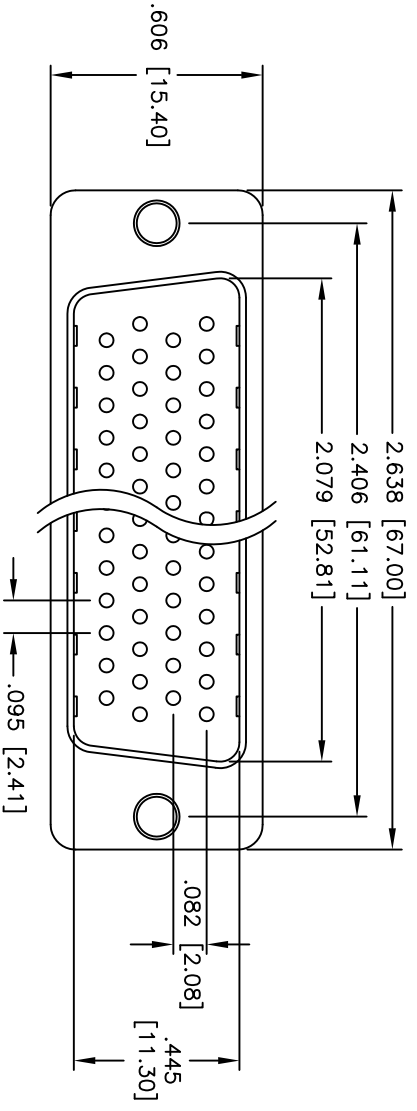

SPECIFICATIONS:

- Material: PBT, glass reinforced, rated UL 94V-0
- Insulator color: Black
- Contacts: Phosphor Bronze
- Shell: Steel, Tin plated
- Hardware: Brass, Nickel plated
- Plating: Gold flash over Nickel underplate overall

- Electrical:
 - Operating voltage: 250 VAC max
 - Current rating: 5 Amps max
 - Contact resistance: 20 mohms max
 - Insulation resistance: 5,000 Mohms min
 - Dielectric withstanding voltage: 1,000 VAC for 1 minute
- Temperature Rating:
 - Operating temperature: -65°C to +125°C
- Environmental:
 - Lead free, RoHS compliant
- Recommended soldering temp: 235°C for 5 seconds



UNLESS OTHERWISE SPECIFIED ALL DIMENSIONS ARE IN INCHES [MM]	
TOLERANCES: EXCEPT AS NOTED	
INCHES	HOLDS
.X ± .10	ØX ± .10
.XX ± .020	ØXX ± .015
.XXX ± .015	ØXXX ± .010
APPROVALS	DATE
DRAWN	SS
CHECKED	
APPROVED	

ADAM TECH
 909 Rahway Avenue, Union, NJ 07083
 Phone: 908-687-5000 Fax: 908-687-5710

TITLE: 78 POS. HIGH DENSITY D-SUB PLUG
 PCB TAILS, RIVETED #4-40 CLINCH NUTS

SIZE	PART NO.	REV.
X	HD778-PT-SL	-
REF:	SCALE: NTS	SHEET 1 OF 1