

Rev	AWO #	Description	Date	Appr
-		RELEASED	10/28/09	

APPROVED: _____
 DATE: _____ TITLE: _____

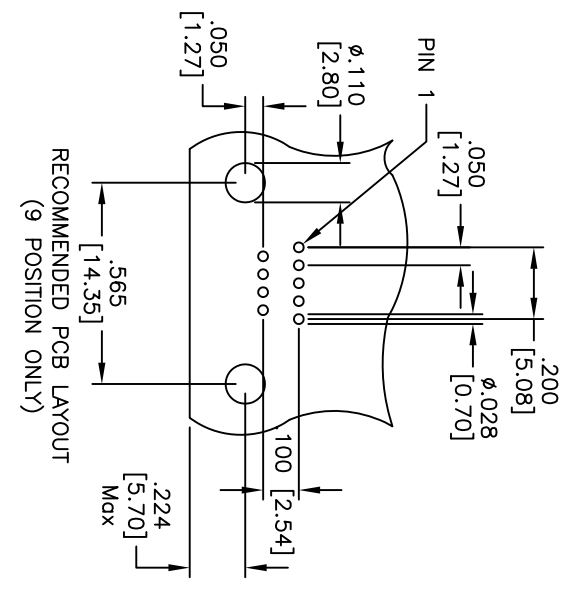
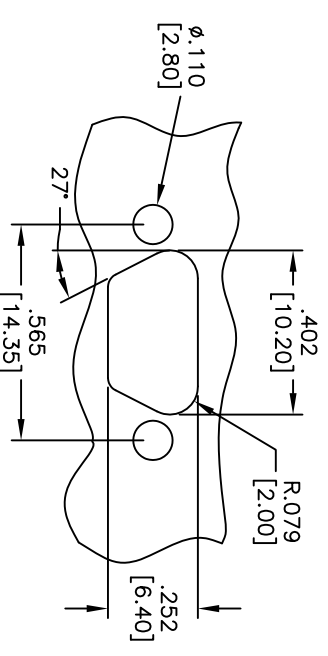
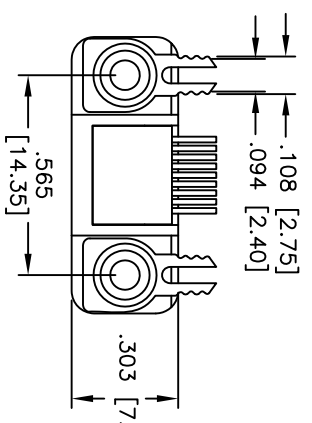
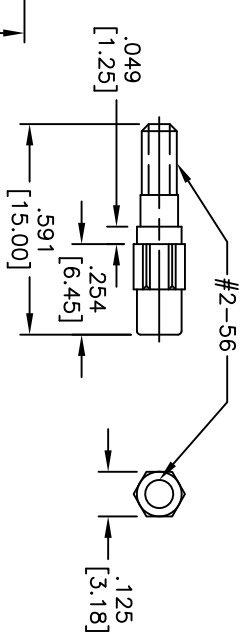
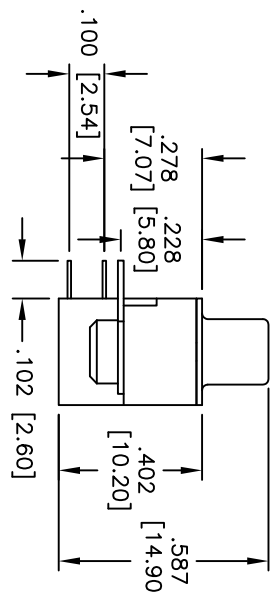
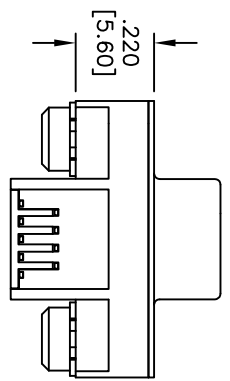
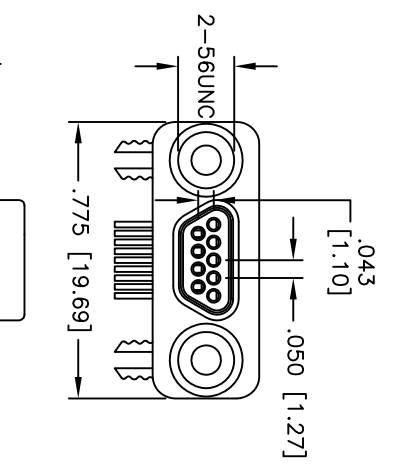

Bulkhead Cutouts For SBUS

RECOMMENDED PCB LAYOUT
(9 POSITION ONLY)

SPECIFICATIONS:

- Material: Insulator: Thermoplastic, rated UL 94V-0
- Insulator color: Black
- Contacts: Copper Alloy
- Shell: Cold Roller Steel, Tin plated
- Plating: 15u" Gold over Nickel underplate on mating end, Tin over Copper underplate on tails.

- Electrical: Current rating: 1 Amps
- Contact resistance: 45 mohms max
- Insulation resistance: 1000 Mohms min
- Dielectric withstanding voltage: 500 VAC for 1 minute
- Temperature Rating: Operating temperature: -55°C to +85°C

Environmental:

- Lead free, RoHS compliant
- Recommended soldering temp: 235°C for 5 seconds



UNLESS OTHERWISE SPECIFIED ALL DIMENSIONS ARE IN INCHES [MM]	
TOLERANCES: EXCEPT AS NOTED	INCHES
.X ± .10	ØX ± .10
.XX ± .020	ØXX ± .015
.XXX ± .015	ØXXX ± .010
APPROVALS	DATE
DRAWN	DY
CHECKED	
APPROVED	

ADAM TECH
 909 Rahway Avenue, Union, NJ 07083
 Phone: 908-687-5000 Fax: 908-687-5710

TITLE: MICRO MINIATURE CONNECTOR,
 RIGHT ANGLE TYPE

SIZE: X PART NO.: DE09-SG-22

REF: S00133T SCALE: NTS SHEET 1 OF 1