

Rev	AWO #	Description	Date	Appr
-		RELEASED	5/16/06	

APPROVED: \_\_\_\_\_  
 DATE: \_\_\_\_\_ TITLE: \_\_\_\_\_

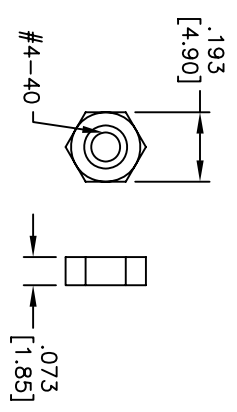
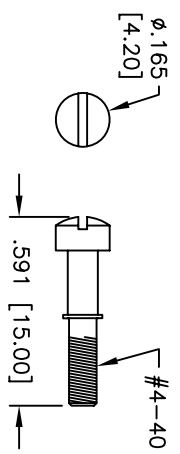
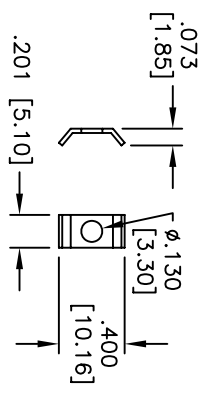
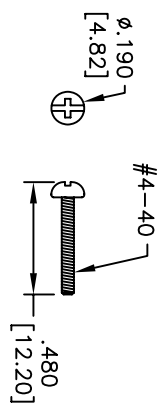
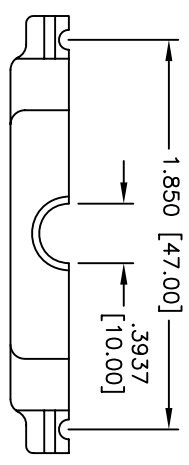
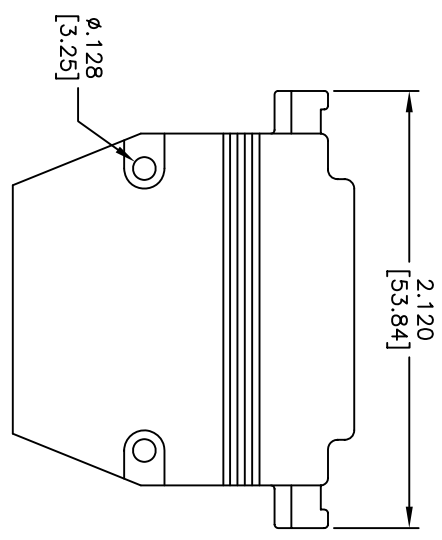
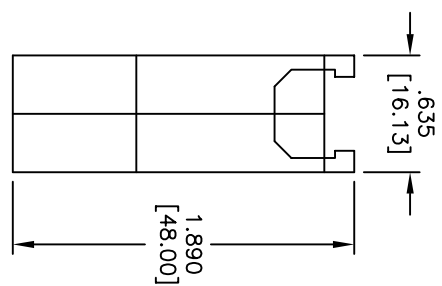

**SPECIFICATIONS:**

Material: Aluminum Die Cast  
 Hardware: Copper Alloy, Nickel plated  
 Environmental: Lead free, RoHS compliant



UNLESS OTHERWISE SPECIFIED  
 ALL DIMENSIONS ARE INCHES [MM]  
 TOLERANCES: EXCEPT AS NOTED  
 INCHES: .X ± .10 ØXX ± .015  
 .XX ± .020 ØXXX ± .010  
 .XXX ± .015  
 APPROVALS: \_\_\_\_\_ DATE: \_\_\_\_\_

**ADAM TECH**  
 909 Rahway Avenue, Union, NJ 07083  
 Phone: 908-687-5000 Fax: 908-687-5710

DRAWN	SS	5/16/06
CHECKED		
APPROVED		

TITLE	METAL HOOD FOR 25 POSITION D-SUB WITH SHORT SCREWS	
SIZE	PART NO.	REV.
X	DB25-HD-AL-SS	-
REF:	SCALE: NTS	SHEET 1 OF 1