

50 PIN COMPACT FLASH SOCKET STRADDLE MOUNT

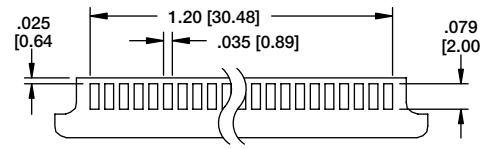

Recommended PCB Layout

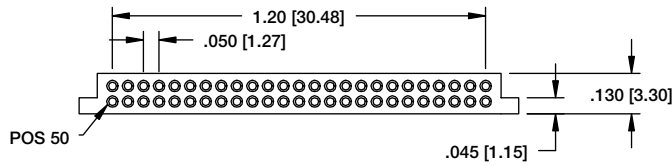
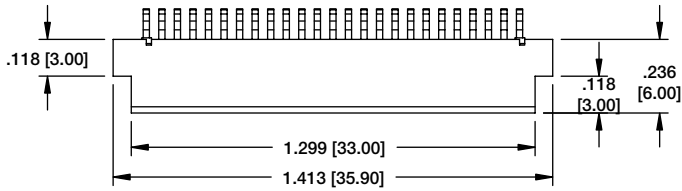
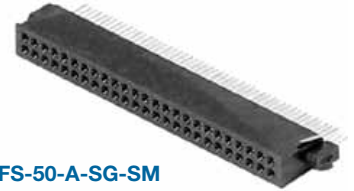

CFS-50-A-SG-SM

50 PIN COMPACT FLASH SOCKET SURFACE MOUNT

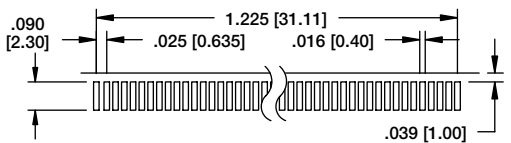
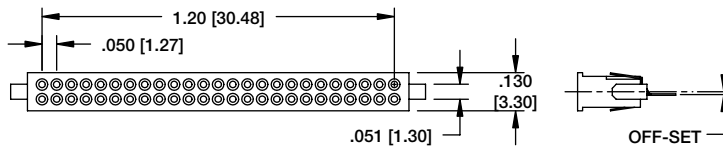
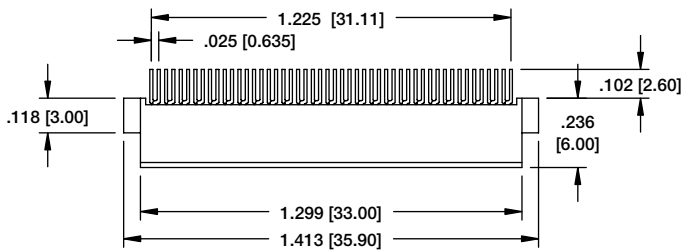

Recommended PCB Layout

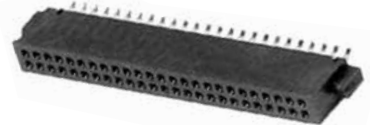

CFS-50-A-SMT-B

ADAM TECH PART NO.	"X" OFFSET
CFS-50-A-SMT-B	.012 [0.30]
CFS-50-A-SMT-C	.023 [0.60]
CFS-50-A-SMT-D	.035 [0.95]

68 PIN COMPACT FLASH SOCKET STRADDLE MOUNT

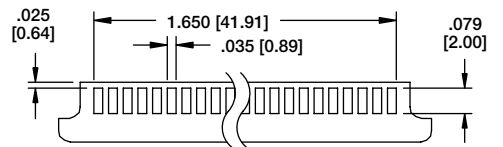
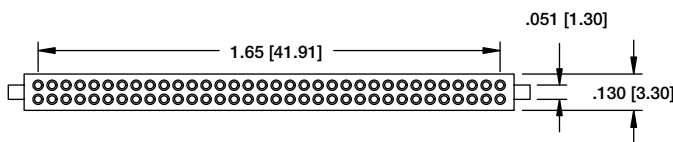
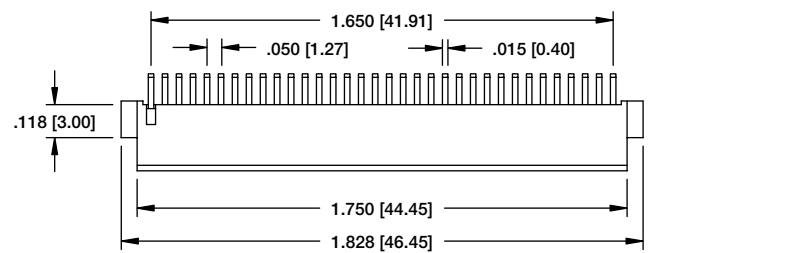

Recommended PCB Layout

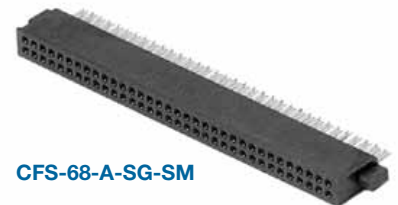

CFS-68-A-SG-SM

50 PIN COMPACT FLASH, TYPE 1

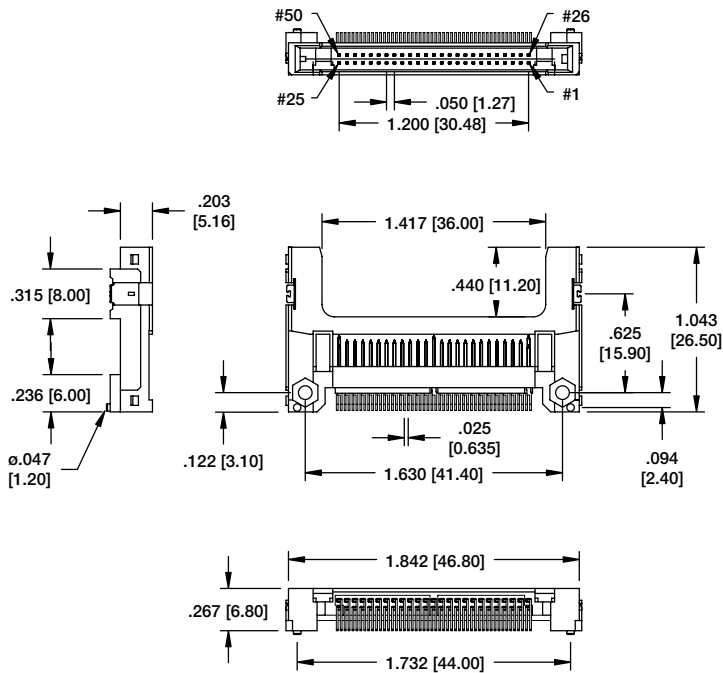

Part Nos. Available
CF1-50-A-SG (Standard Type)
CF1R-50-A-SG (Reverse Type) Not Shown

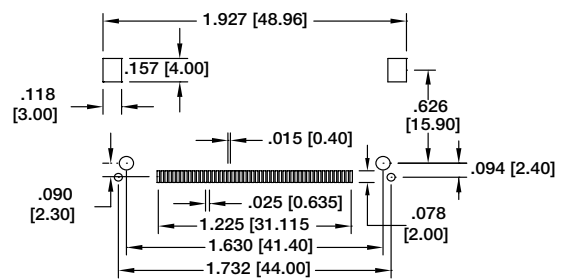

50 PIN COMPACT FLASH, EJECTOR (FOR USE WITH CF1 AND CF1R SERIES SOCKETS)

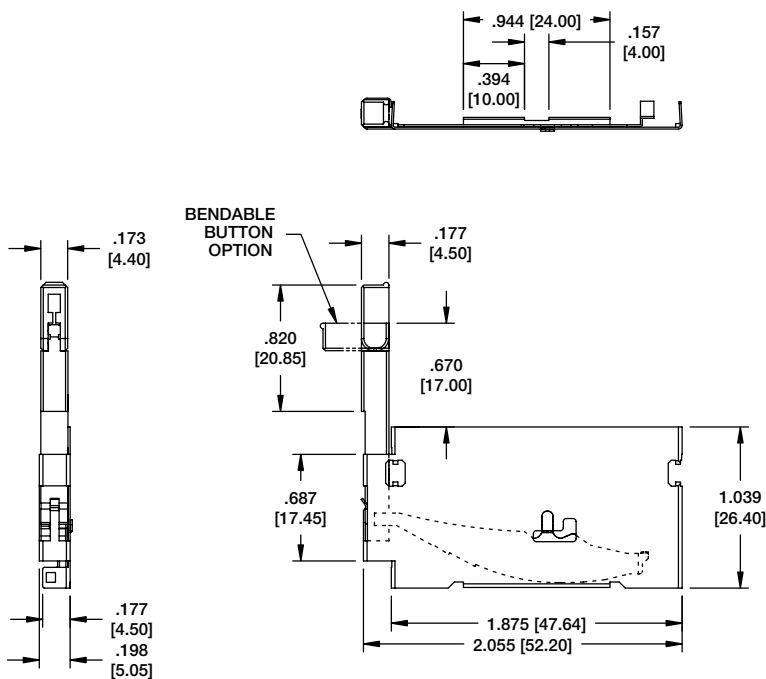

Part Nos. Available
CFE-50-L15 (15.0mm long Ejector button)
CFE-50-L20 (20.0mm long Ejector button)
CFE-50-L22 (22.0mm long Ejector button)

DIM X
1.581 [40.16]
1.525 [38.74]

OPTIONAL STANDOFF
.047 [1.20]
STANDARD TYPE
.055 [1.40] REVERSE TYPE

ALSO AVAILABLE WITH EJECTOR

**50 PIN COMPACT FLASH,
SLIM TYPE (FITS CF TYPE 1 AND 2)**

CFA-50-A-SG-B-1

CFA-50-A-SG-1 (Standard Type, 40.16mm)
CFR-50-A-SG-C-1 (Reverse Type, 40.16mm, Standoff 1.4mm)
CFA-50-A-SG-2 (Standard Type, 38.74mm)
CFR-50-A-SG-2 (Reverse Type, 38.74mm)

OPTIONAL STANDOFF
.047 [1.20]
STANDARD TYPE
.055 [1.40] REVERSE TYPE

**50 PIN COMPACT FLASH,
SHORT SLIDE TYPE (FITS TYPE 2)**

CF-50-C-SG