

### RCA-4

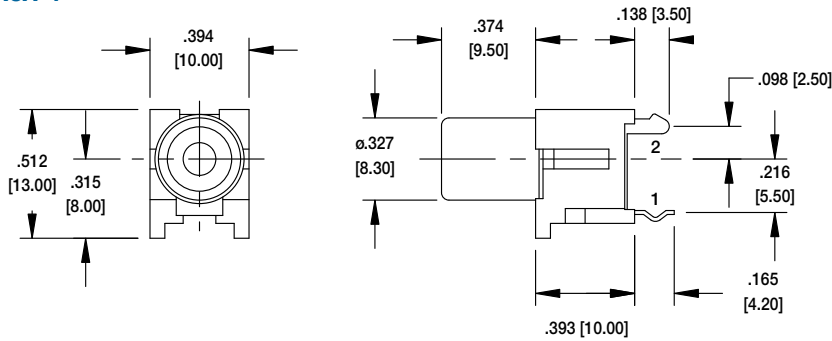

Recommended PCB Layout  
(Bottom View)



RCA-4-1-B

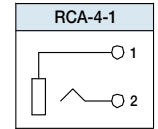

### RCA-5

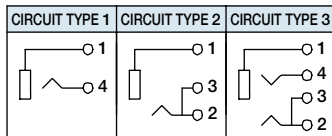
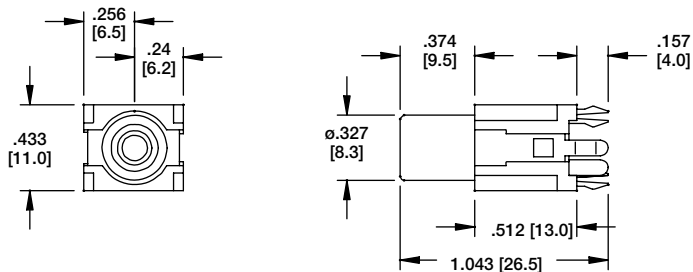

CIRCUIT

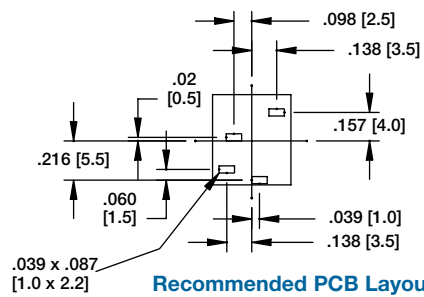

Recommended PCB Layout  
(Bottom View)



RCA-5-2-R

### RCA-6

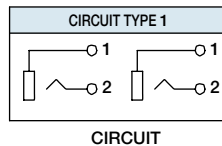
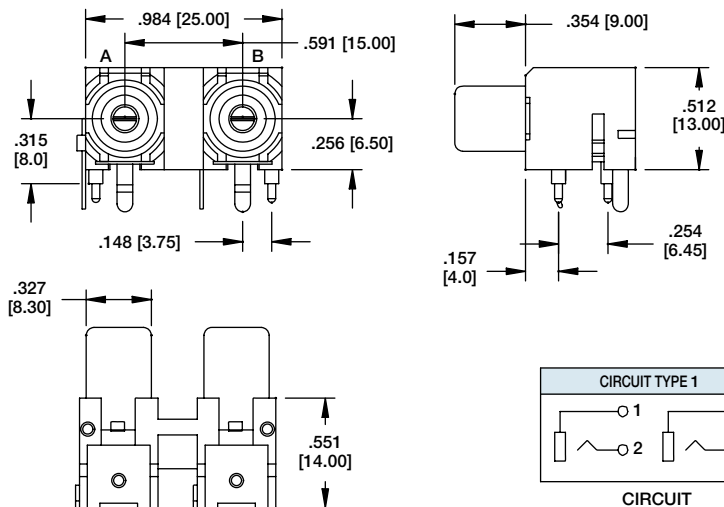

RCA-6-1-R/Y

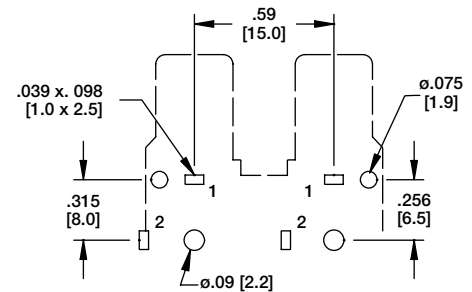

Recommended PCB Layout  
(Bottom View)