

**DFW**  
FEMALE DISCRETE WIRE  
IDC CONNECTOR

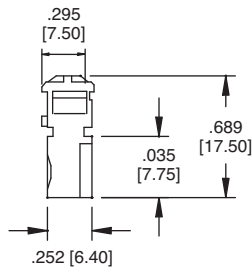

**DFW-04**

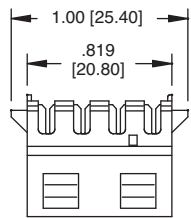
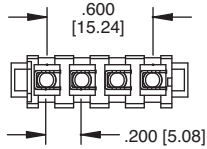

**DFW-B**  
END MOUNT COVER



**DFW-B-04**

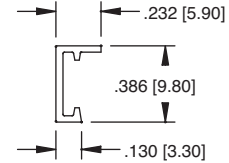
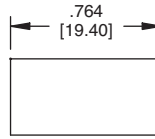

**DFW-C**  
FEED THRU COVER



**DFW-C-04**

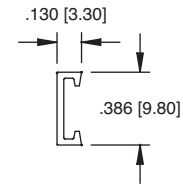
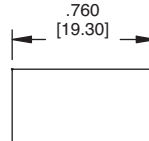

**DDR**  
MALE RIGHT ANGLE  
PCB MOUNT



**DDR-04**

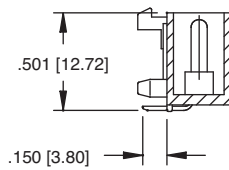
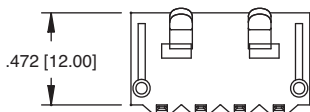
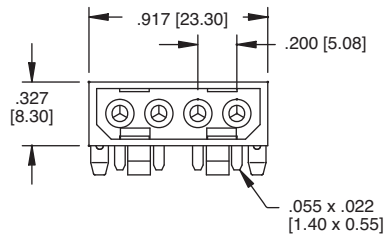

**DDS**  
MALE STRAIGHT  
PCB MOUNT



**DDS-04**

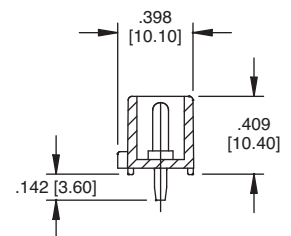
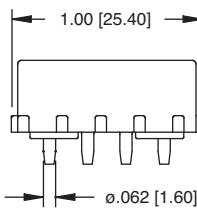
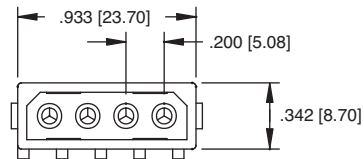

## DDH MALE HOUSING

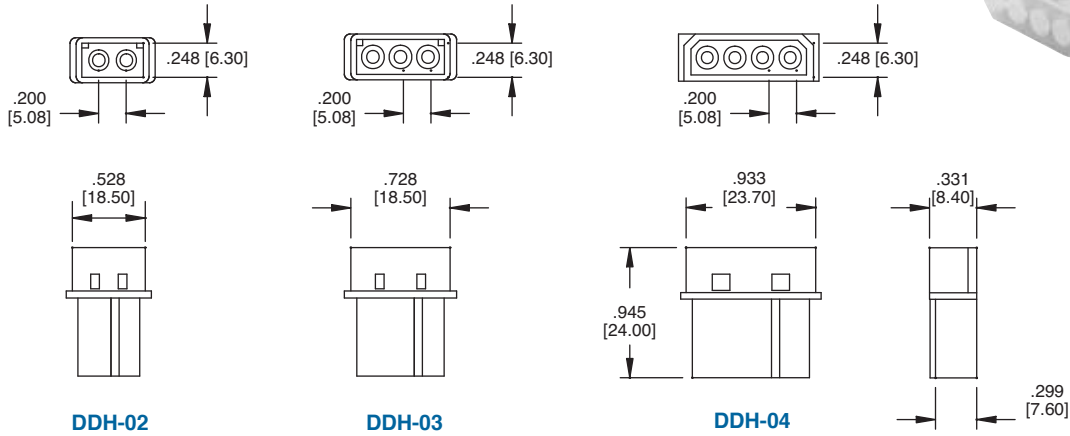

DDH-04

## DDF FEMALE HOUSING

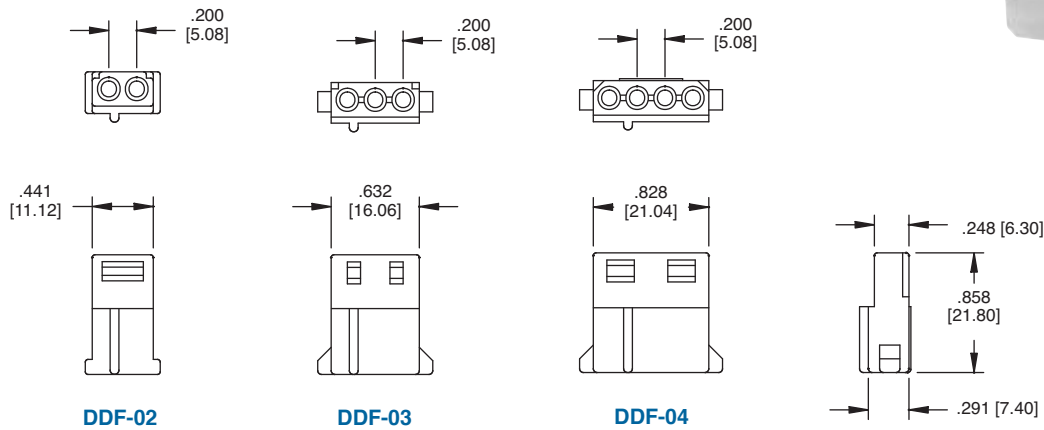

DDF-04

## DMC-01-R MALE CRIMP CONTACT

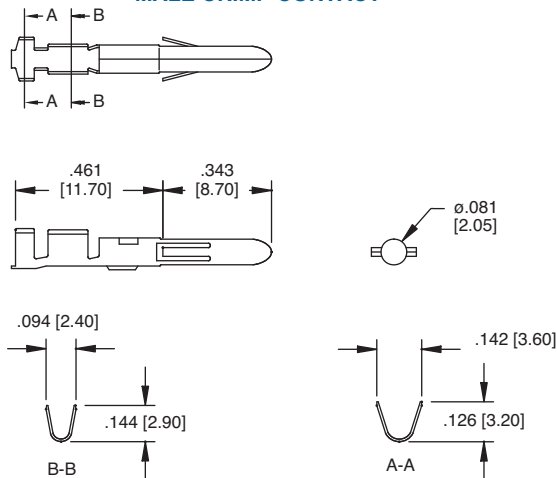

## DFC-01-R FEMALE CRIMP CONTACT

