

## 50 PIN COMPACT FLASH SOCKET STRADDLE MOUNT

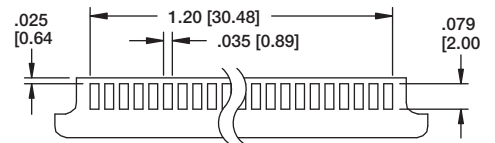

Recommended PCB Layout

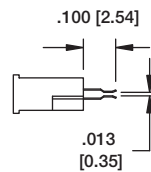
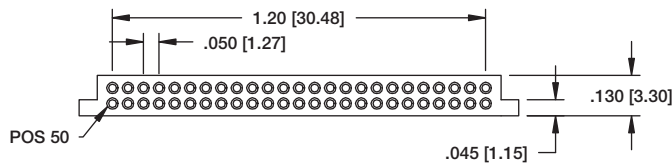
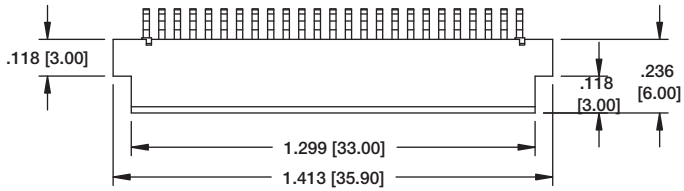

CFS-50-A-SG-SM

## 50 PIN COMPACT FLASH SOCKET SURFACE MOUNT

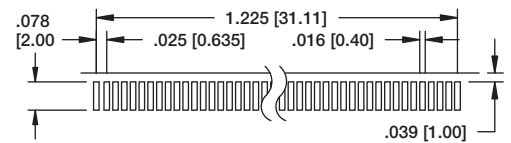
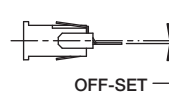
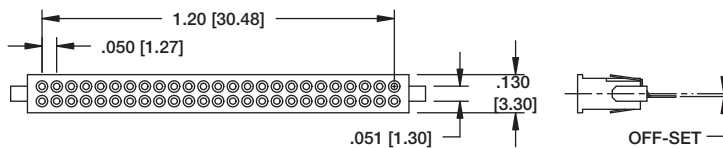
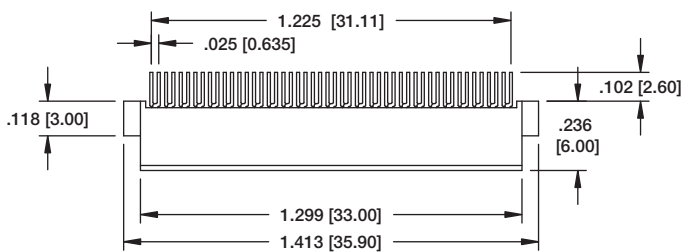

Recommended PCB Layout



ADAM TECH PART NO.	"X" OFFSET
CFS-50-A-SMT-A	0.00 [0.00]
CFS-50-A-SMT-B	.012 [0.30]
CFS-50-A-SMT-C	.023 [0.60]
CFS-50-A-SMT-D	.035 [0.90]

## 68 PIN COMPACT FLASH SOCKET STRADDLE MOUNT

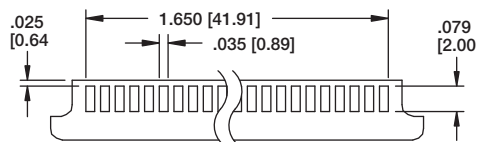
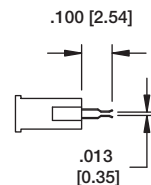
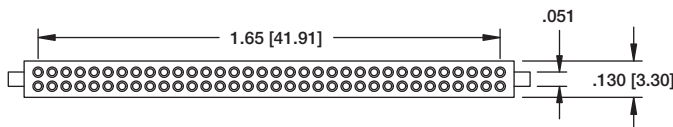
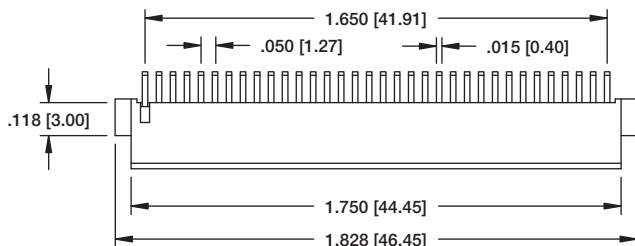

Recommended PCB Layout

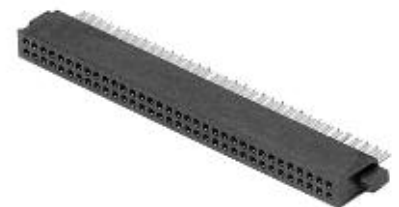

CFS-68-A-SG-SM

## 50 PIN COMPACT FLASH, TYPE 1

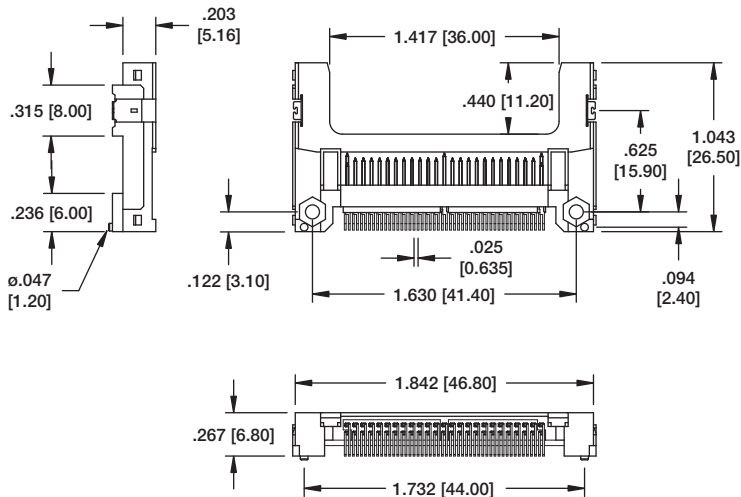
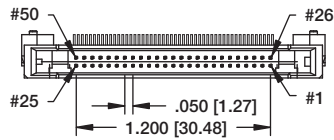

Part Nos. Available  
**CF1-50-A-SG (Standard Type)**  
**CF1R-50-A-SG (Reverse Type) Not Shown**

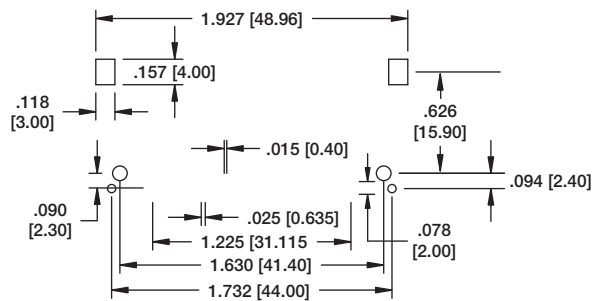

## 50 PIN COMPACT FLASH, EJECTOR (FOR USE WITH CF1 AND CF1R SERIES SOCKETS)

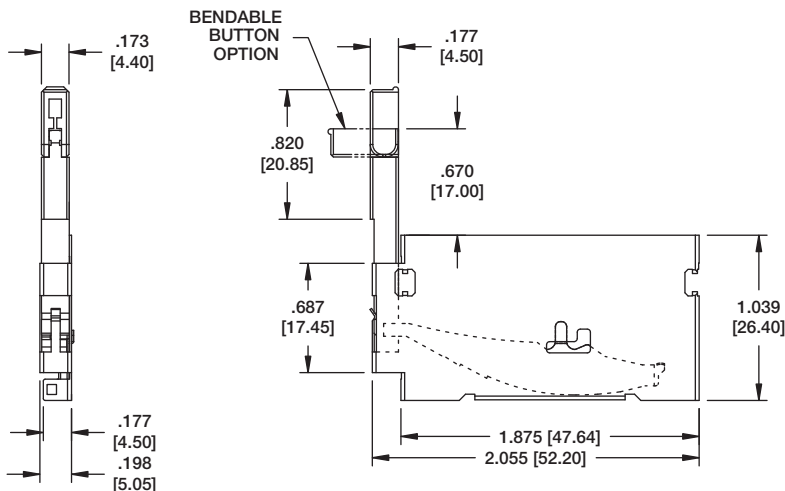
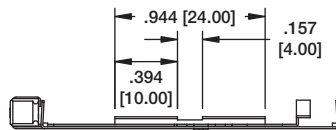

Part Nos. Available  
**CFE-50-L15 (15.0mm long Ejector button)**  
**CFE-50-L20 (20.0mm long Ejector button)**  
**CFE-50-L22 (22.0mm long Ejector button)**

**50 PIN COMPACT FLASH,  
SLIM TYPE (FITS CF TYPE 1 AND 2)**

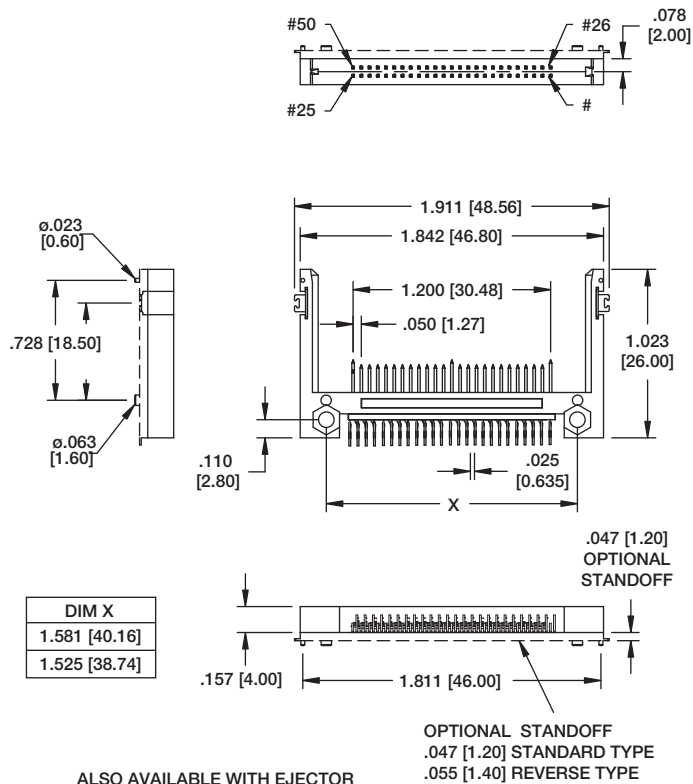

**CFA-50-A-SG-B-1**

- Part Nos. Available**
- CFA-50-A-SG-1 (Standard Type, 40.16mm)
  - CFA-50-A-SG-B-1 (Standard Type, 40.16mm, Standoff 1.2mm)
  - CFR-50-A-SG-1 (Reverse Type, 40.16mm)
  - CFR-50-A-SG-C-1 (Reverse Type, 40.16mm, Standoff 1.4mm)
  - CFA-50-A-SG-2 (Standard Type, 38.74mm)
  - CFA-50-A-SG-B-2 (Standard Type, 38.74mm, Standoff 1.2mm)
  - CFR-50-A-SG-2 (Reverse Type, 38.74mm)
  - CFR-50-A-SG-C-2 (Reverse Type, 38.74mm, Standoff 1.4mm)

**50 PIN COMPACT FLASH,  
SHORT SLIDE TYPE (FITS TYPE 2)**

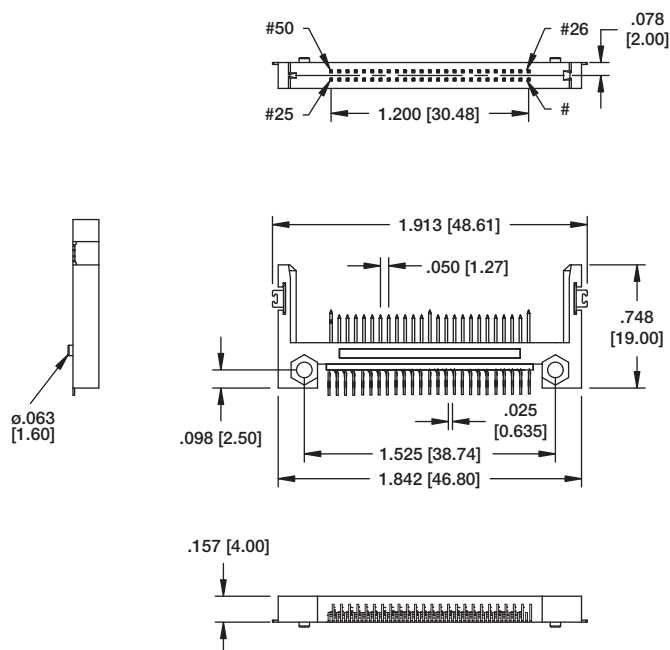

**CF-50-C-SG**

