

ADC-007

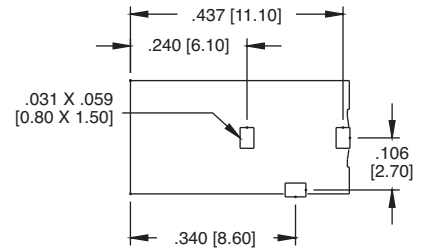

ADC-007-3

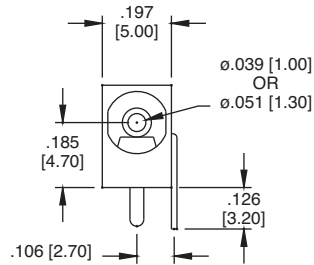

Recommended PCB Layout

ADC-009



ADC-009-3

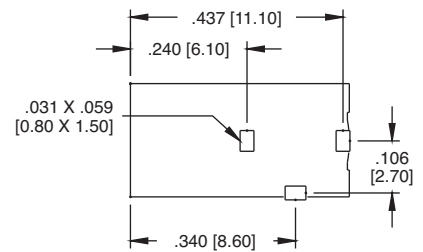
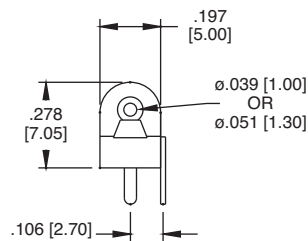

Recommended PCB Layout

ADC-011



ADC-011-3

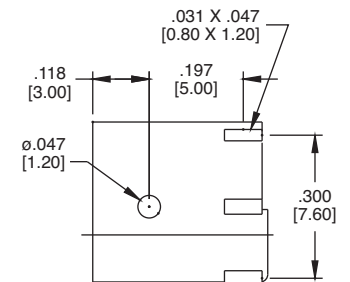
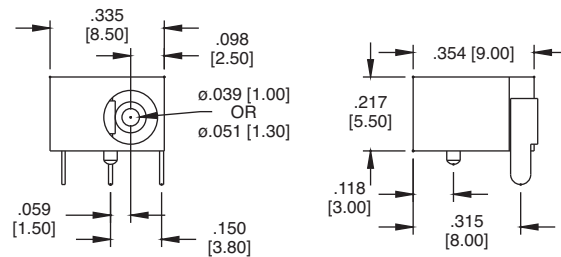

Recommended PCB Layout

ADC-021



ADC-021-3

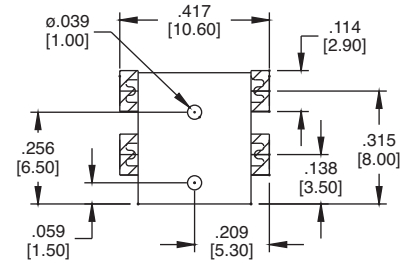
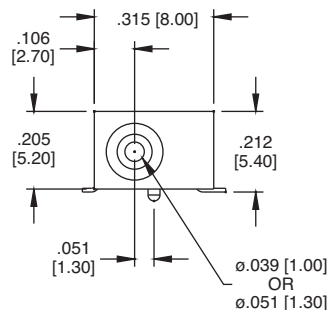

Recommended PCB Layout

ADC-029



ADC-029-1

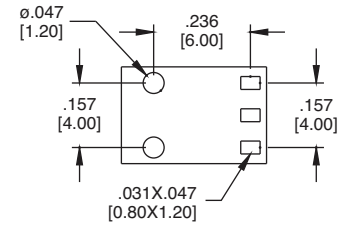
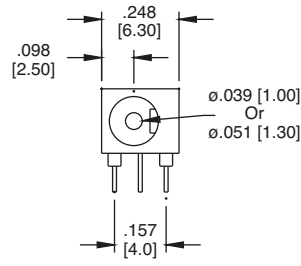

Recommended PCB Layout

ADC-002



ADC-002-2

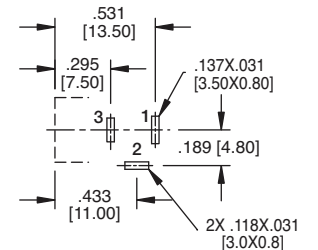
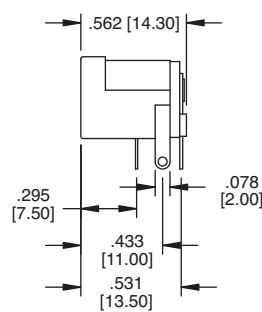
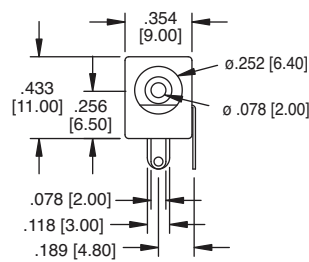

Recommended PCB Layout

ADC-024



ADC-024-8

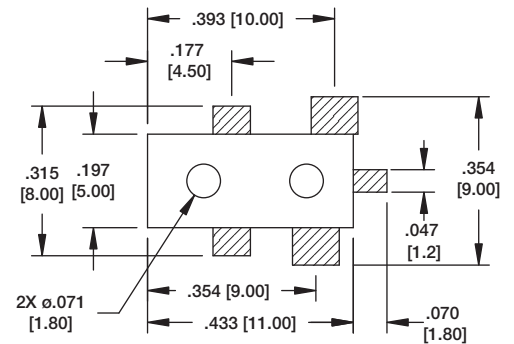
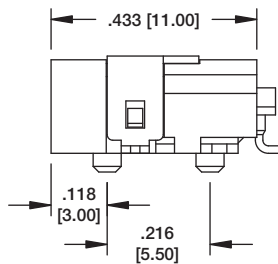
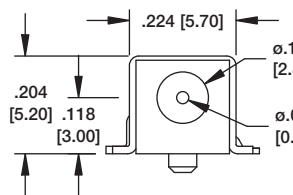

Recommended PCB Layout

ADC-028



ADC-028-2

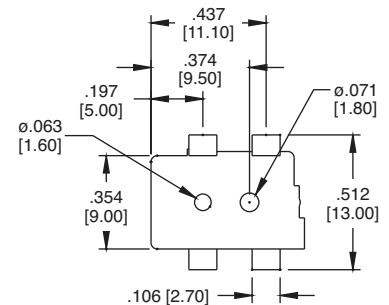
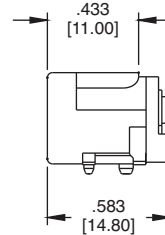
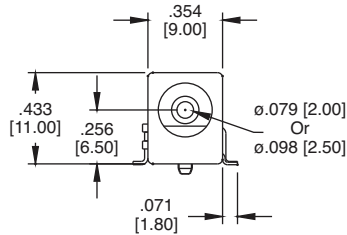

Recommended PCB Layout

ADC-027



ADC-027



ADC-027-M8

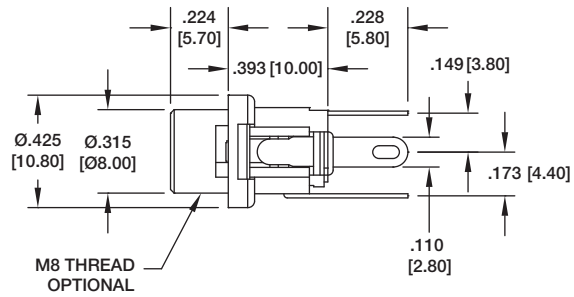
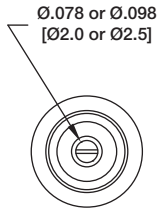

ADC-085



ADC-085-1

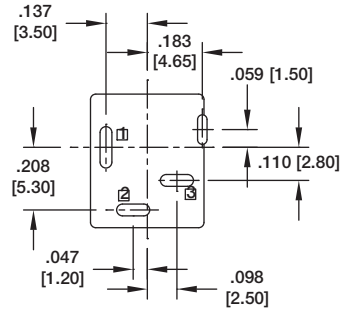
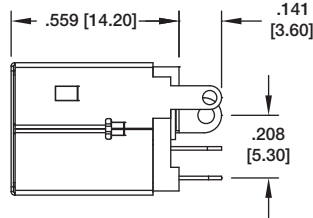
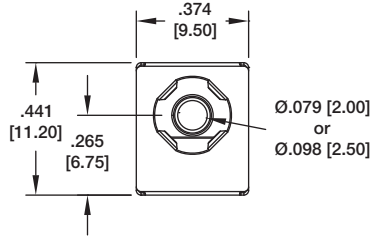

Recommended PCB Layout

ADC-086



ADC-085-2

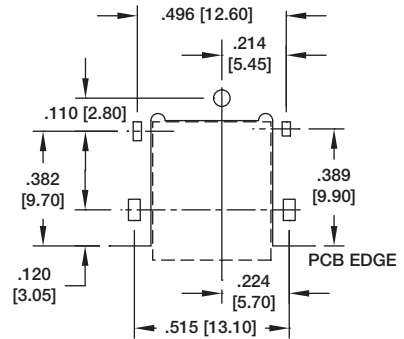
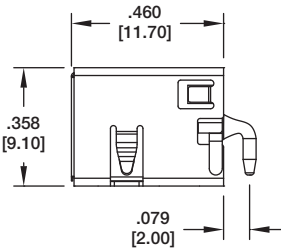
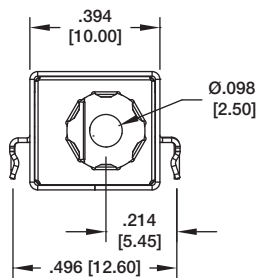

Recommended PCB Layout

ADC-087



ADC-087

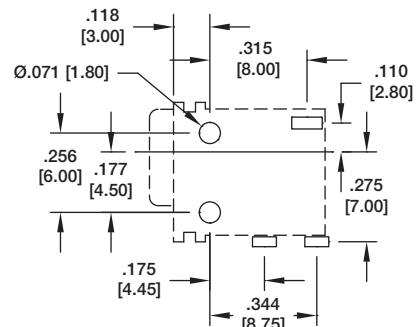
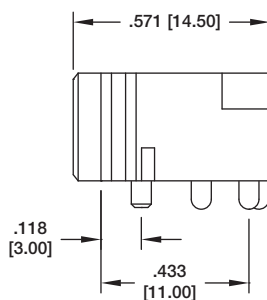
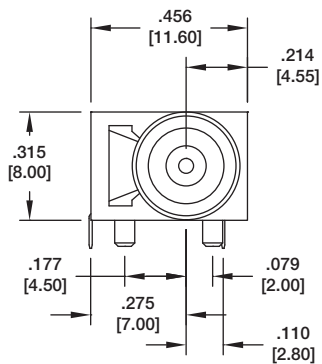

Recommended PCB Layout

ADC-010



ADC-010-1

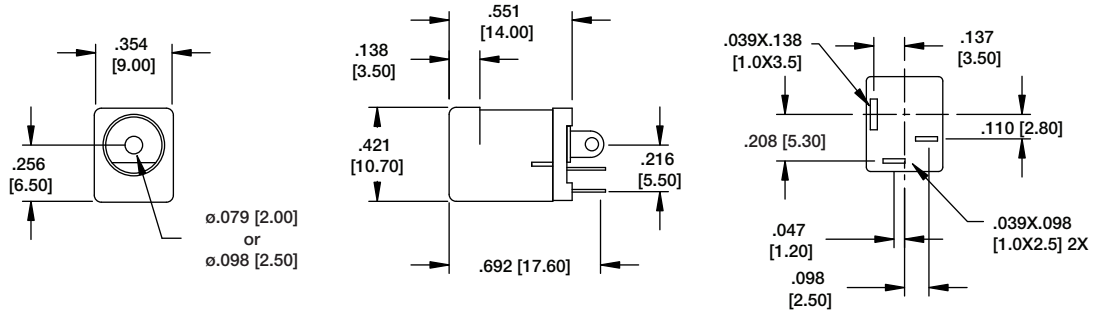

Recommended PCB Layout

ADC-015



ADC-015-2

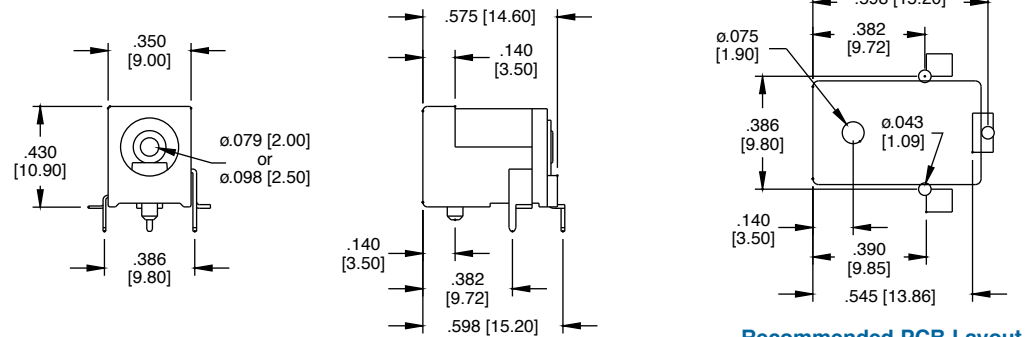

Recommended PCB Layout

ADC-045A



ADC-045A-1

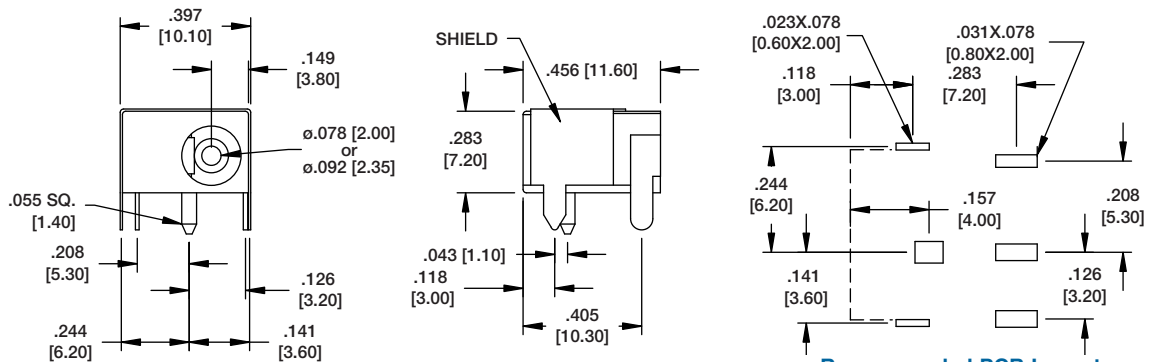

Recommended PCB Layout

ADP-PLUG WITH STRAIN RELIEF

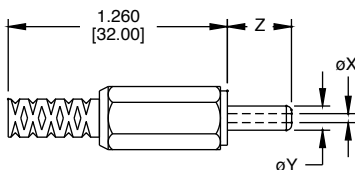

PLUG WITH STRAIN RELIEF	X	Y	Z
ADP-X/Y/Z-SR	ø.039 [1.00]	ø.137 [3.50]	.374 [9.50]
ADP-X/Y/Z-SR	ø.082 [2.10]	ø.216 [5.50]	.374 [9.50]
ADP-X/Y/Z-SR	ø.098 [2.50]	ø.216 [5.50]	.374 [9.50]

ADP-PLUG WITHOUT STRAIN RELIEF

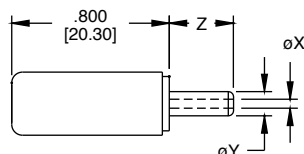

PLUG WITHOUT STRAIN RELIEF	X	Y	Z
ADP-X/Y/Z	ø.039 [1.00]	ø.137 [3.50]	.374 [9.50]
ADP-X/Y/Z	ø.082 [2.10]	ø.216 [5.50]	.374 [9.50]
ADP-X/Y/Z	ø.098 [2.50]	ø.216 [5.50]	.374 [9.50]