

RF1 TYPE 01
BNC RIGHT ANGLE FEMALE PCB MOUNT

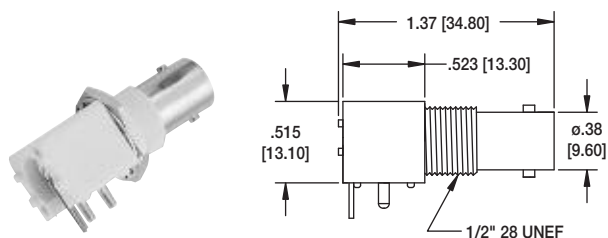

RF1-01-P-00-50

RF1 TYPE 01V
BNC STRAIGHT FEMALE PCB MOUNT

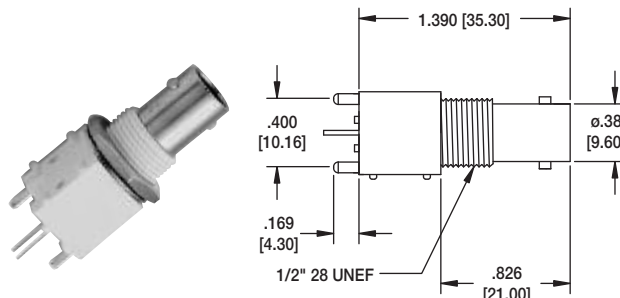

RF1-01V-P-00-75

RF1 TYPE 01A
BNC HIGH PROFILE RIGHT ANGLE FEMALE PCB MOUNT

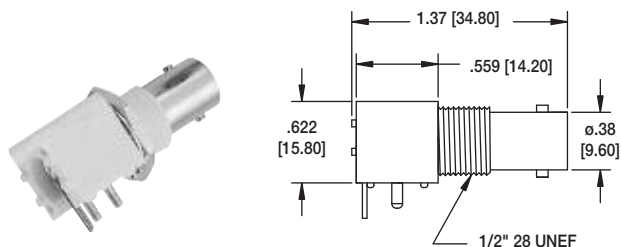

RF1-01A-P-00-50

RF1 TYPE 03
BNC MALE CRIMP

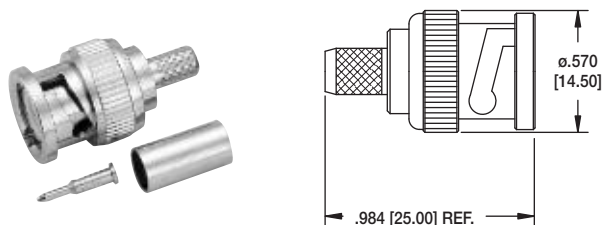

RF1-03-D-05-75

RF1 TYPE 04
BNC FEMALE BULKHEAD CRIMP

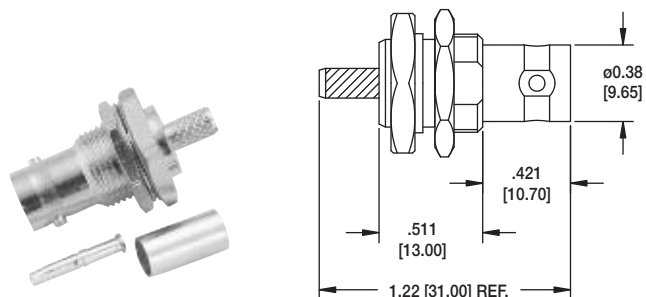

RF1-04-T-01-75

RF1 TYPE 05
BNC MALE TO BNC DOUBLE FEMALE

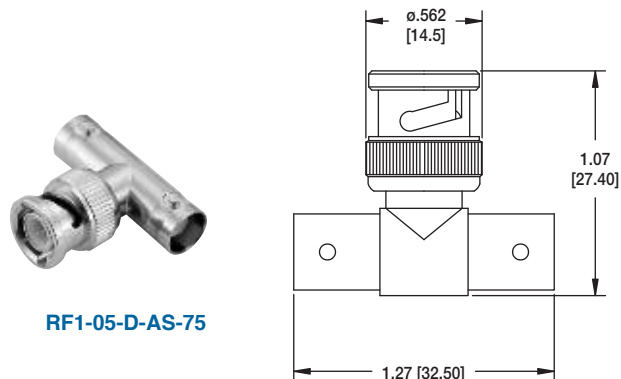

RF1-05-D-AS-75

RF1 TYPE 06
BNC MALE "Y" ADAPTER



RF1-06-D-AS-50

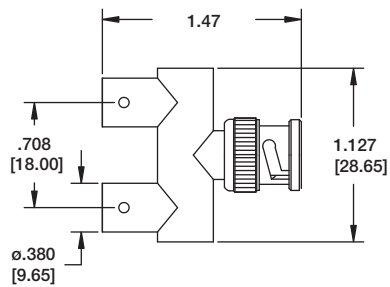

RF1 TYPE 07
BNC FEMALE PC BOARD MOUNT



RF1-07-T-00-75

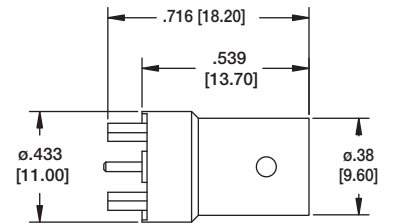

RF2 TYPE 01
SMA RIGHT ANGLE MALE CRIMP TYPE



RF2-01-T-02-50

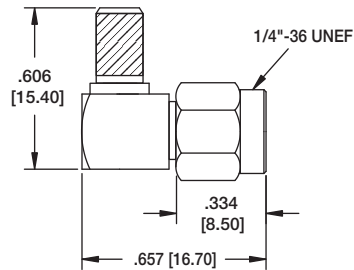

RF2 TYPE 02
SMA MALE CRIMP TYPE



RF2-02-T-02-50-G

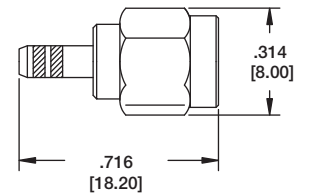

RF2 TYPE 03
SMA RIGHT ANGLE FEMALE PC BOARD MOUNT



RF2-03-T-00-50-G

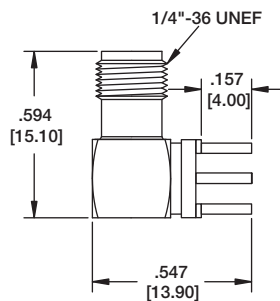

RF2 TYPE 04
SMA FEMALE PC BOARD MOUNT



RF2-04-T-00-50-G

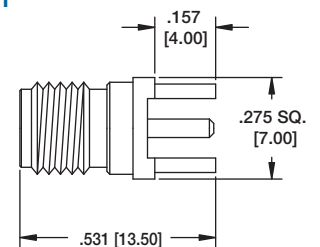

RF2 TYPE 05
SMA FEMALE CHASSIS CRIMP



RF2-05-T-00-50-G

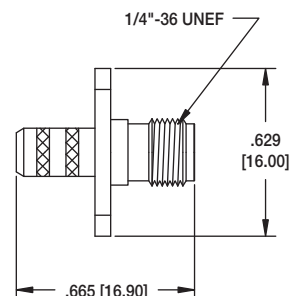

RF2 TYPE 06
SMA FEMALE BULKHEAD CRIMP



RF2-06-T-02-50

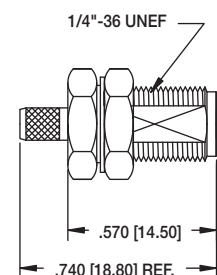

RF2 TYPE 07
SMA DOUBLE FEMALE ADAPTOR



RF2-07-T-AS-50

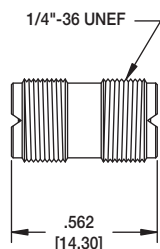

RF3 TYPE 01
SMB MALE CRIMP



RF3-01-T-01-50-G

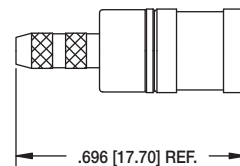

RF3 TYPE 02
SMB FEMALE CRIMP



RF3-02-T-01-50-G

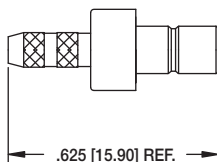

RF3 TYPE 03
SMB MALE RIGHT ANGLE CRIMP



RF3-03-T-03-75-G

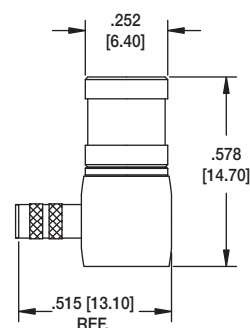

RF3 TYPE 04
SMB RIGHT ANGLE MALE PCB MOUNT



RF3-04-T-00-50-G

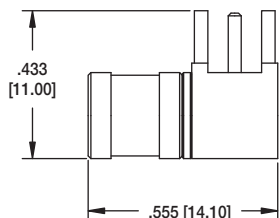

RF3 TYPE 05
SMB FEMALE PCB MOUNT



RF3-05-T-00-50-G

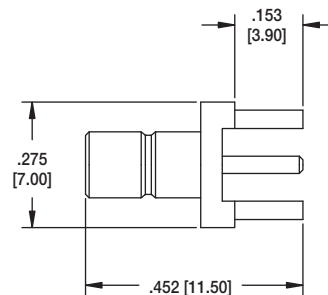

RF3 TYPE 06
SMB RIGHT ANGLE FEMALE PCB MOUNT



RF3-06-T-00-50-G

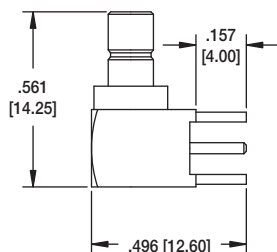

RF4 TYPE 01
F FEMALE RIGHT ANGLE PCB MOUNT



RF4-01-T-00-75

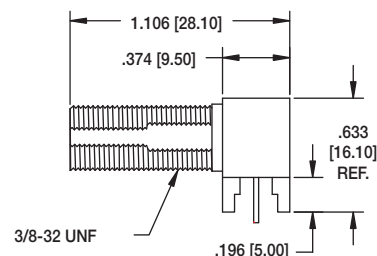

RF4 TYPE 02
F MALE TO MALE

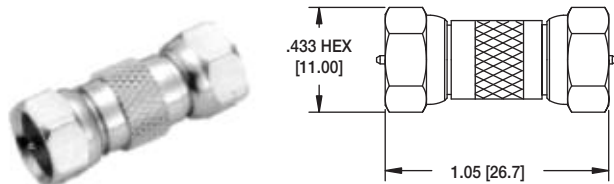

RF4-02-T-AS-75

RF5 TYPE 01
N MALE CRIMP TYPE

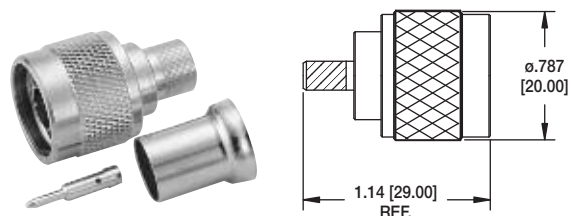

RF5-01-D-01-50

RF5 TYPE 02
N FEMALE PANEL RECEPTACLE

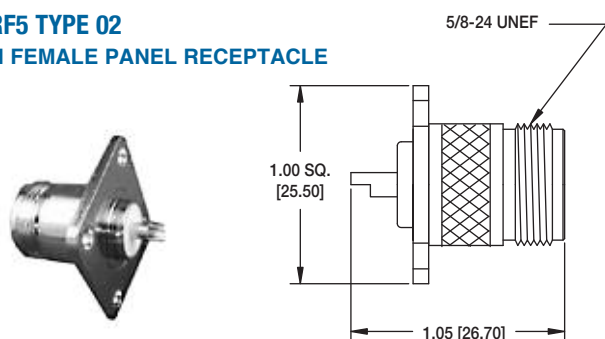

RF5-02-D-01-50

RF6 TYPE 01
UHF DOUBLE FEMALE

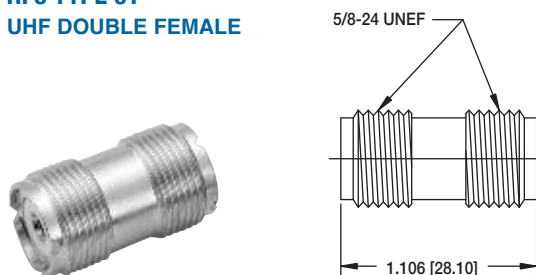

RF6-01-D-AS-50

RF7 TYPE 01
TNC MALE CRIMP

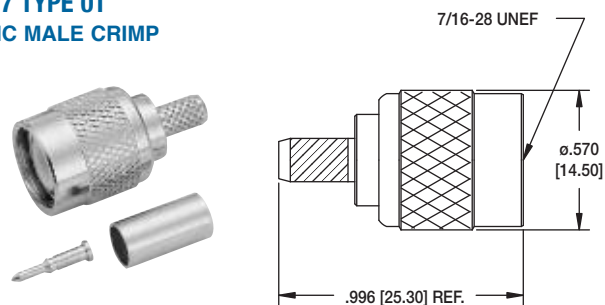

RF7-01-D-02-50

RF8 TYPE 01
FME MALE CRIMP

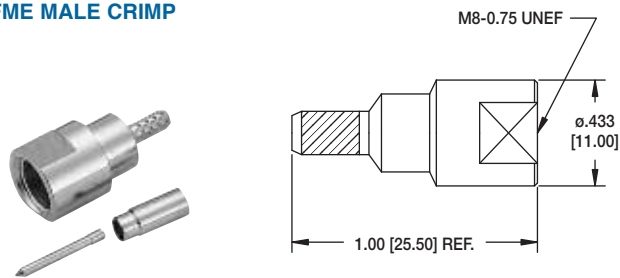

RF8-01-T-01-50-G

RF8 TYPE 02
FME MALE TO BNC MALE

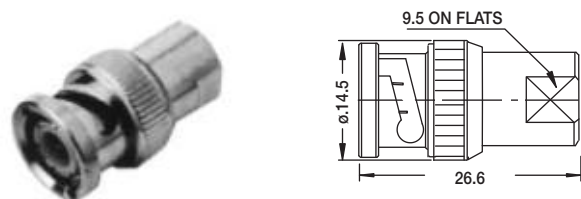

RF8-02-T-AS-50

RF9 TYPE 01
MINI UHF MALE CRIMP TYPE

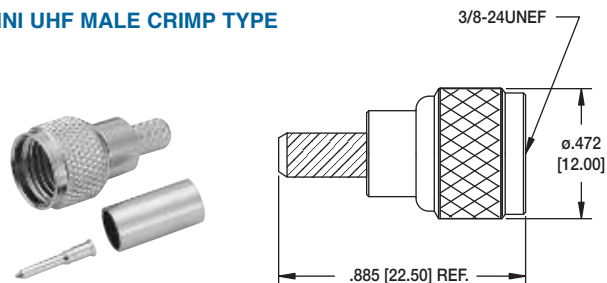

RF7-01-D-02-50

**RF7 TYPE 08
TNC FEMALE CRIMP**

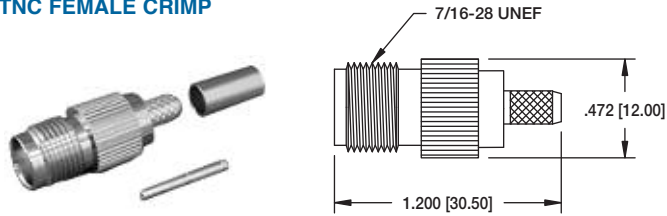

RF7-08-T-02-50-G

**RF11 TYPE 01
MCX FEMALE VERTICAL SMT MOUNT**

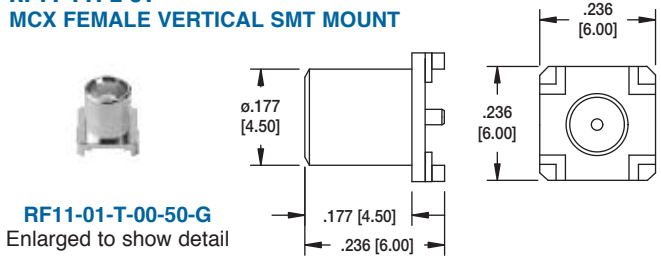

RF11-01-T-00-50-G
Enlarged to show detail

**RF12 TYPE 04
MMCX MALE VERTICAL PCB MOUNT**

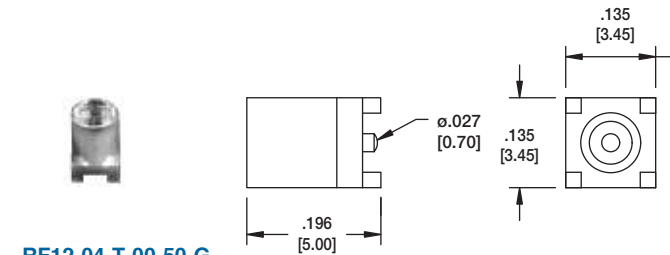

RF12-04-T-00-50-G
Enlarged to show detail

**RF12 TYPE 05
MMCX PCB MOUNT**

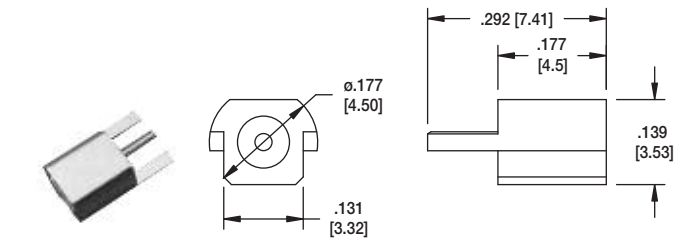

RF12-05-T-00-50-G

**RF20 TYPE 01
MHF SURFACE MOUNT**

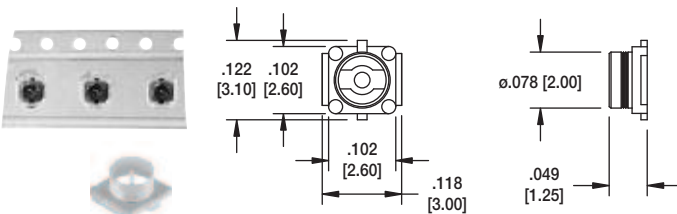

RF20-01-P-00-50-G
Enlarged to show detail

**RF28 TYPE 01
W.FL SURFACE MOUNT**

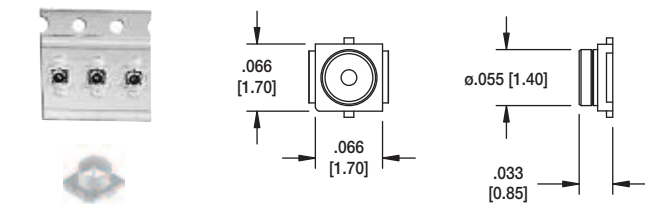

RF28-01-T-00-50-G
Enlarged to show detail

**RF20 TYPE 01 CABLE ASSEMBLY
MATES WITH MHF SMT CONNECTOR**

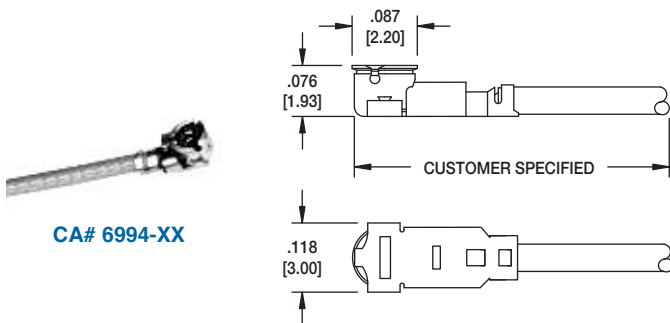

CA# 6994-XX

**RF28 TYPE 01 CABLE ASSEMBLY
MATES W.FL SMT CONNECTOR**

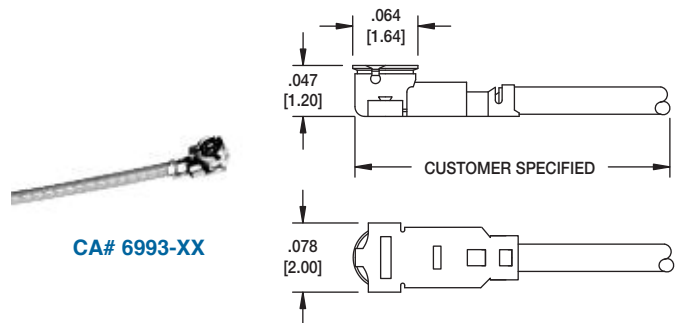

CA# 6993-XX