

USB 2.0, TYPE A, 2 PORT STACKED, RIGHT ANGLE, THRU-HOLE

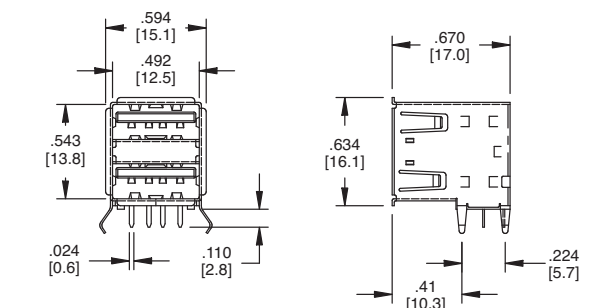

USB-A-D-RA

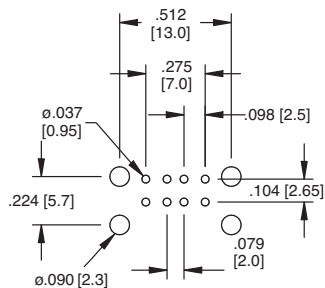

Recommended PCB Layout
(Bottom View)

USB 2.0, TYPE A, 4 PORT STACKED, RIGHT ANGLE, THRU-HOLE

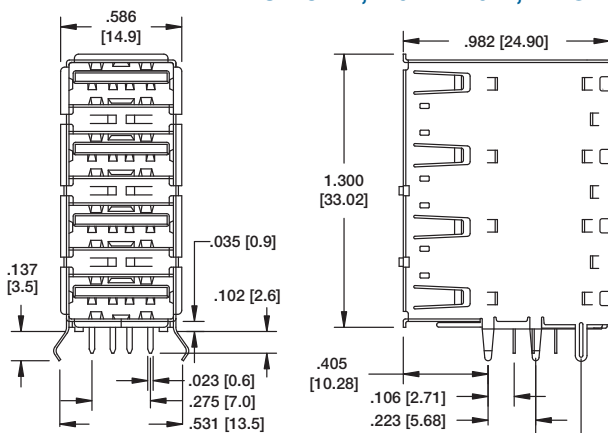

USB-A-Q-RA

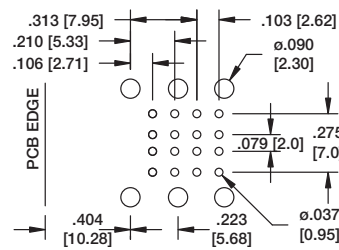

Recommended PCB Layout

USB 2.0, TYPE A, 3 PORT STACKED, RIGHT ANGLE, THRU-HOLE

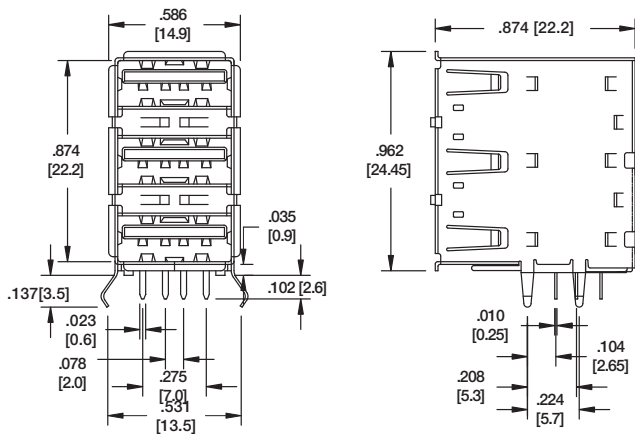

USB-A-T-RA

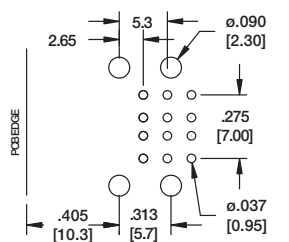

Recommended PCB Layout
(Bottom View)

USB 2.0, TYPE A, 2 PORT STACKED, VERTICAL, THRU-HOLE

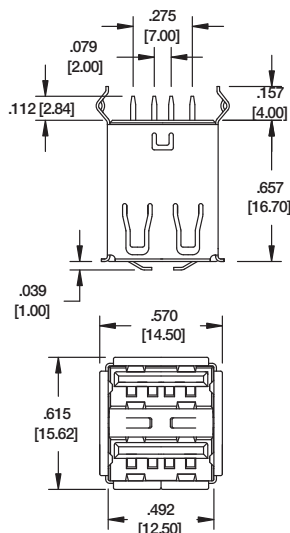

USB-A-D-VT

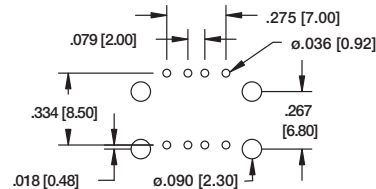

Recommended PCB Layout