

Ordering Information pg. 9

**TYPE 2B  
SHIELDED**

6P6C  
6P4C  
8P8C

**MTJ-662BX1-FS**

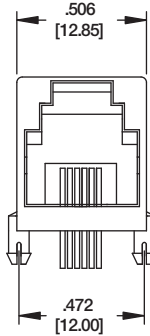

6 POS  
2B SHIELDED

**MTJ-882BX1-FS**

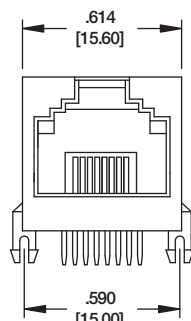

8 POS  
2B SHIELDED

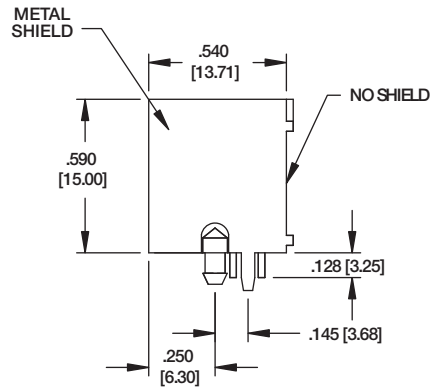

**MTJ-662BX1-FS**



**MTJ-882BX1-FS**

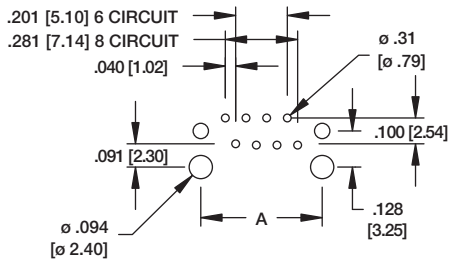

**Recommended PCB Layout**

DIM. "A"	
TYPE2B 6P6C	.472 [12.00]
TYPE2B 8P8C	.590 [15.00]

**TYPE Q  
COMPACT JACK  
4P4C**

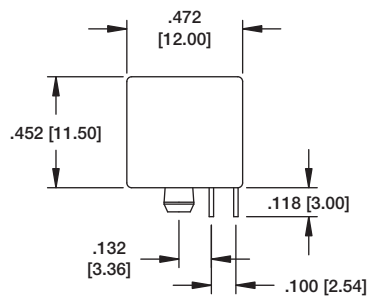
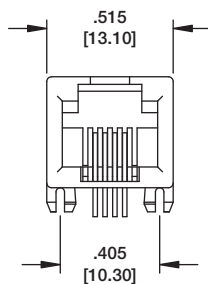

**MTJ-44QX1**

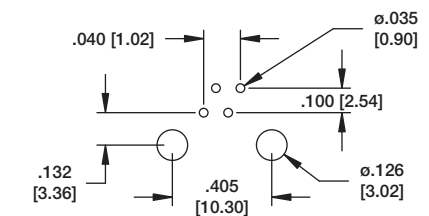
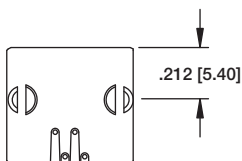

**Recommended PCB Layout**